



FUR INSTITUTE
OF CANADA

INSTITUT DE LA FOURRURE
DU CANADA



CERTIFIED TRAPS IDENTIFICATION SHEETS

INTERNATIONAL HUMANE TRAPPING STANDARDS

JANUARY 2024



FUR INSTITUTE
OF CANADA

INSTITUT DE LA FOURRURE
DU CANADA

Published under the authority of the **Canadian Wildlife Directors Committee.**

All rights reserved. The content of this publication may not be reproduced or transmitted in any form or by any means without the prior written permission of the Fur Institute of Canada.

ISMN: 978-0-9694537-8-9

Periodicity: annual

This publication was produced under the direction of:

Pierre Canac-Marquis

Canadian Trap Research and Certification Program Coordinator, Fur Institute of Canada

JANUARY 2024

TABLE OF CONTENTS

Chapter 1 - KILLING TRAPS

BELISLE "CLASSIC"	7
BELISLE "SUPER X"	9
BMI "BODY GRIPPER"	11
BRIDGER	13
DUKE	15
CONV (Netherlands)	17
EIABZUGSEISEN (Germany)	18
FMB + FS (Netherlands)	19
HZ (Netherlands)	20
KLEINER SCHWANENHALS (Germany)	21
KT-140 (Russia)	22
KORO	23
LDL, "B" and "C MAGNUM" SERIES	25
LDL, "C" SERIES	27
OUELL	29
RUDY	31
SAUVAGEAU 1000-11 F	33
SAUVAGEAU "2001" SERIES	35
SAUVAGEAU C120 MAGNUM	37
SAUVAGEAU C120, "REVERSE BEND"	39
SPECIES SPECIFIC DISLOCATOR HALF MAGNUM	41
TRIPLE M	43
VICTOR	44
WOODSTREAM ONEIDA VICTOR CONIBEAR	45
WOODSTREAM ONEIDA VICTOR "NORTHWOODS"	47
WOODSTREAM ONEIDA VICTOR CONIBEAR "STAINLESS STEEL"	49
WCS "TUBE TRAP INT'L"	50

Chapter 2 - LIVE CAPTURE TRAPS

BELISLE FOOTSNARE	53
BEER	55
BREATHE EASY	56
BRIDGER ALASKAN NO 5	57
BRIDGER BRAWN	58
BRIDGER "COIL SPRINGS" OFFSET + LAMINATED JAWS	59
BRIDGER "T3"	61
COMSTOCK	62
DAM BEAVER	63
DUFFER	64
DUKE	65
DUKE DP	66
EGG TRAP	67
EZEE SET	68
HANCOCK	69
KORO "KLAM"	70
LAY	71
LIL' GRIZZ GETRZ	72
LIVESTOCK PROTECTION	73
MB	74
MUSKWA	75
NO-BS-LURES	76
ONEIDA VICTOR "COIL SPRINGS" OFFSET + LAMINATED JAWS	77
ONEIDA VICTOR "COIL SPRINGS" NO 3 NON-OFFSET + LAMINATED JAWS	79
ONEIDA VICTOR "SOFT CATCH"	81
ONEIDA VICTOR "SOFT CATCH" NO 3 (MODIFIED FOR WOLF)	83
RUDY RED WOLF	84

Chapter 1
KILLING TRAPS



Certified trap identification sheet

BELISLE "CLASSIC"

JANUARY 2024

SET TRAP



CLOSED TRAP

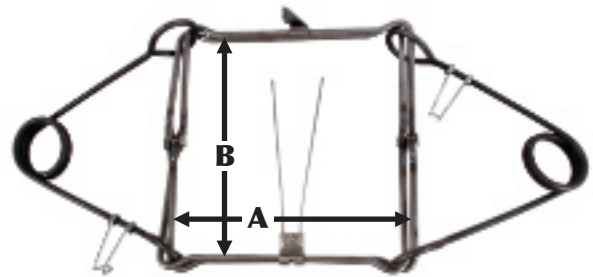

MODEL	AIHTS CERTIFICATION		INSIDE MEASUREMENT TAKEN ON THE SAME JAW (CLOSED TRAP)	
	NUMBER	TARGET SPECIES	WIDTH (A)	HEIGHT (B)
120		Muskrat (underwater)	5 inch (128 mm)	5 inch (128 mm)
220	QRG	Muskrat (underwater), Raccoon	7 ³ / ₄ inch (197 mm)	7 ³ / ₄ inch (197 mm)
330	QCF	Muskrat (underwater), Beaver	10 inch (254 mm)	10 inch (254 mm)

LOCATION OF THE
CERTIFICATION NUMBER



Commercial name of trap :
BELISLE "CLASSIC"

CLOSED TRAP

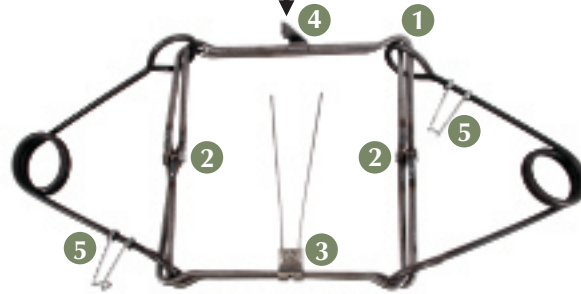

CHARACTERISTICS



1



2



3



4



5



Certified trap identification sheet

JANUARY 2024

BELISLE "SUPER X"

SET TRAP



CLOSED TRAP

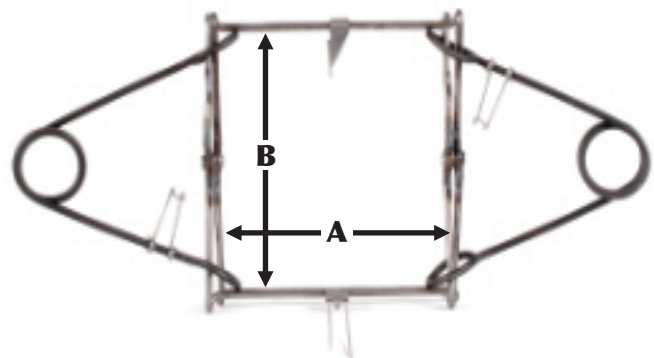

MODEL	AIHTS CERTIFICATION		INSIDE MEASUREMENT TAKEN ON THE SAME JAW (CLOSED TRAP)	
	NUMBER	TARGET SPECIES	WIDTH (A)	HEIGHT (B)
SUPER X 110 1 SPRING	QAK	Muskrat (underwater + on land), Weasel	4 ⁵ / ₈ inch (120 mm)	4 ⁷ / ₈ inch (123 mm)
SUPER X 120	QMC	Martens, Fisher, Muskrat (underwater + on land), Weasel	4 ⁵ / ₈ inch (120 mm)	4 ⁷ / ₈ inch (123 mm)
SUPER X 160	QRF	Raccoon, Fisher, Martens, Muskrat (underwater)	6 ¹ / ₄ inch (158 mm)	6 ¹ / ₈ inch (155 mm)
SUPER X 220	QRE	Raccoon, Fisher, Muskrat (underwater), Otter	7 ¹ / ₄ inch (185 mm)	6 ⁷ / ₈ inch (175 mm)
SUPER X 280	QCG	Raccoon, Beaver, Muskrat (underwater), Otter, Canada Lynx, Bobcat	8 ⁵ / ₃₂ inch (208 mm)	8 ¹ / ₈ inch (207 mm)
SUPER X 330	QCC	Beaver, Muskrat (underwater), Otter, Canada Lynx, Bobcat	10 ⁷ / ₁₆ inch (265 mm)	10 ¹ / ₈ inch (257 mm)

LOCATION OF THE
CERTIFICATION NUMBER



Commercial name of trap :
BELISLE "SUPER X"

CLOSED TRAP

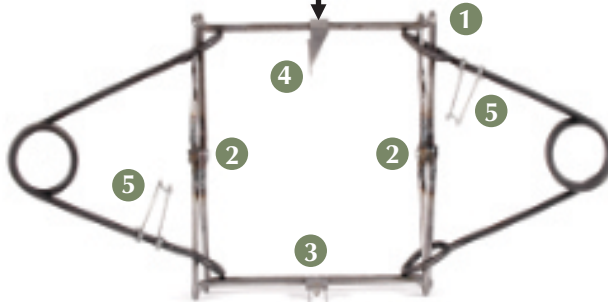

CHARACTERISTICS

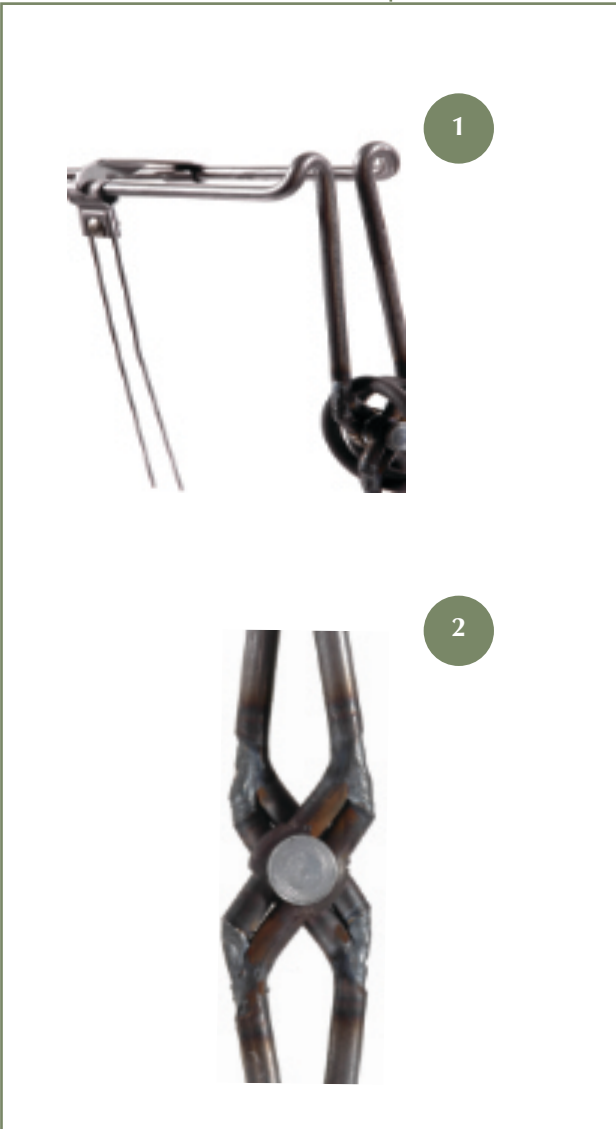



Certified trap identification sheet

BMI "BODY GRIPPER"

JANUARY 2024

SET TRAP



CLOSED TRAP

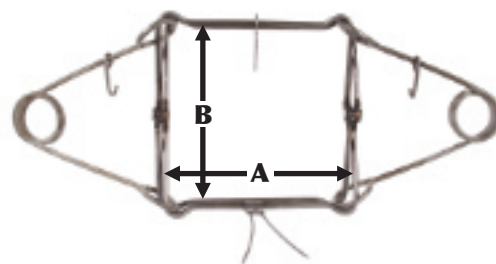

MODEL	AIHTS CERTIFICATION		INSIDE MEASUREMENT TAKEN ON THE SAME JAW (CLOSED TRAP)	
	NUMBER	TARGET SPECIES	WIDTH (A)	HEIGHT (B)
BMI 60	QEC	Muskrat (underwater), Weasel	3 ³ / ₄ inch (94 mm)	4 ¹ / ₂ inch (114 mm)
BMI 110 1 SPRING		Muskrat (underwater)	4 ³ / ₄ inch (121 mm)	4 ⁵ / ₈ inch (120 mm)
BMI 110 MAG 1 SPRING		Muskrat (underwater)	4 ³ / ₄ inch (121 mm)	4 ⁵ / ₈ inch (120 mm)
BMI 120	QAD	Muskrat (underwater + on land)	4 ³ / ₄ inch (121 mm)	4 ⁵ / ₈ inch (120 mm)
BMI 120 MAGNUM	QAE	Muskrat (underwater + on land), Weasel	4 ³ / ₄ inch (121 mm)	4 ⁵ / ₈ inch (120 mm)
BMI 126 MAGNUM	OMB	Muskrat (underwater + on land), Martens, Weasel	4 ³ / ₄ inch (121 mm)	4 ³ / ₄ inch (121 mm)
BMI 160	ORF	Muskrat (underwater), Raccoon	6 inch (152 mm)	6 inch (152 mm)
BMI 220	ORG	Muskrat (underwater), Raccoon, Canada Lynx, Bobcat	7 inch (178 mm)	6 ⁷ / ₈ inch (175 mm)
BMI 220 MAGNUM	QLA	Muskrat (underwater), Canada Lynx, Bobcat	7 inch (178 mm)	6 ⁷ / ₈ inch (175 mm)
BMI 280	OCG	Muskrat (underwater), Beaver, Rac- coon, Canada Lynx, Bobcat	8 ³ / ₈ inch (213 mm)	8 ³ / ₈ inch (213 mm)
BMI 280 MAGNUM	QRM	Muskrat (underwater), Raccoon, Canada Lynx, Bobcat	8 ³ / ₈ inch (213 mm)	8 ³ / ₈ inch (213 mm)
BMI 330	OCF	Muskrat (underwater), Beaver	10 ³ / ₈ inch (264 mm)	9 ³ / ₄ inch (248 mm)
BT300	QCN	Muskrat (underwater), Beaver	10 ³ / ₈ inch (264 mm)	8 ³ / ₈ inch (213 mm)

LOCATION OF THE
CERTIFICATION NUMBER



Commercial name of trap :

BMI "BODY GRIPPER"

CLOSED TRAP

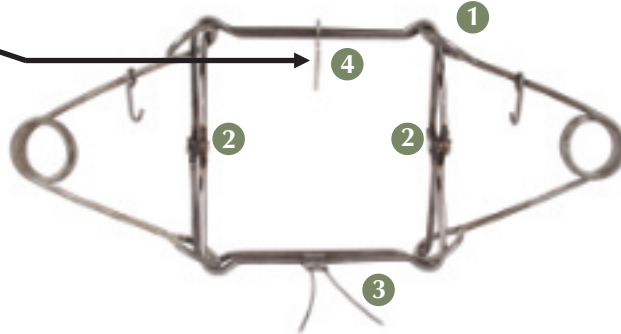

CHARACTERISTICS



"BODY GRIPPER"

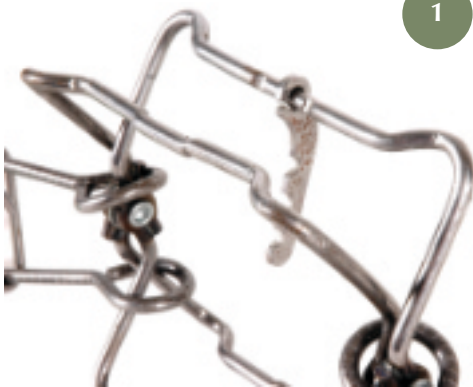

"BODY GRIPPER" MAGNUM





Certified trap identification sheet

BRIDGER

JANUARY 2024

SET TRAP



CLOSED TRAP

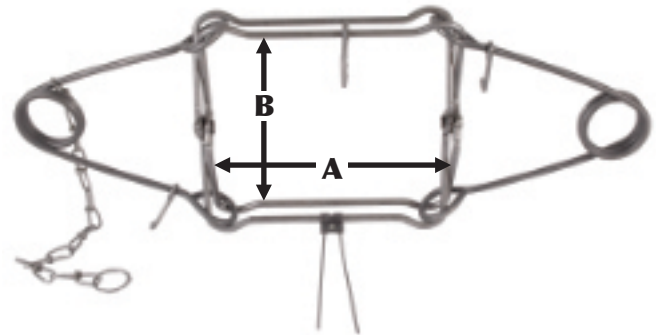

MODEL	AIHTS CERTIFICATION		INSIDE MEASUREMENT TAKEN ON THE SAME JAW (CLOSED TRAP)	
	NUMBER	TARGET SPECIES	WIDTH (A)	HEIGHT (B)
110 1 SPRING		Muskrat (underwater)	4 1/2 inch (114 mm)	4 1/2 inch (114 mm)
120	QAB	Muskrat (underwater + on land), Weasel	4 1/2 inch (114 mm)	4 1/2 inch (114 mm)
160	QRJ	Muskrat (underwater), Raccoon	5 3/4 inch (146 mm)	6 5/16 inch (160 mm)
220	ORD	Muskrat (underwater), Raccoon, Canada Lynx, Bobcat	6 7/8 inch (175 mm)	6 1/2 inch (165 mm)
330	OCD	Muskrat (underwater), Beaver	10 1/2 inch (267 mm)	8 3/4 inch (223 mm)
120 MAGNUM BODY GRIPPER	AAB	Muskrat (underwater + on land), Weasel	4 1/2 inch (114 mm)	4 5/8 inch (120 mm)
155 MAGNUM BODY GRIPPER	AAC	Muskrat (underwater + on land), Weasel	5 3/16 inch (132 mm)	5 3/8 inch (136 mm)
280 MAGNUM BODY GRIPPER	ORH	Muskrat (underwater), Raccoon, Canada Lynx, Bobcat	8 1/2 inch (215 mm)	8 1/4 inch (210 mm)

LOCATION OF THE CERTIFICATION NUMBER



Commercial name of trap :
BRIDGER

CLOSED TRAP

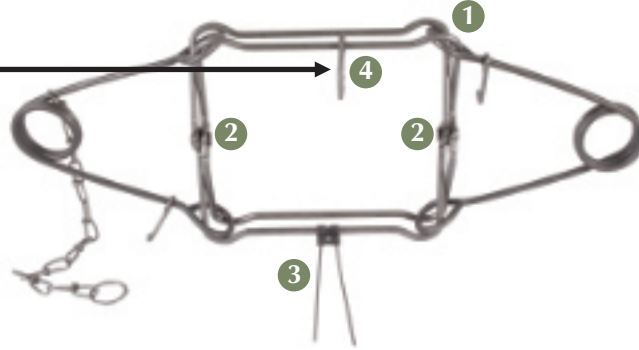

CHARACTERISTICS

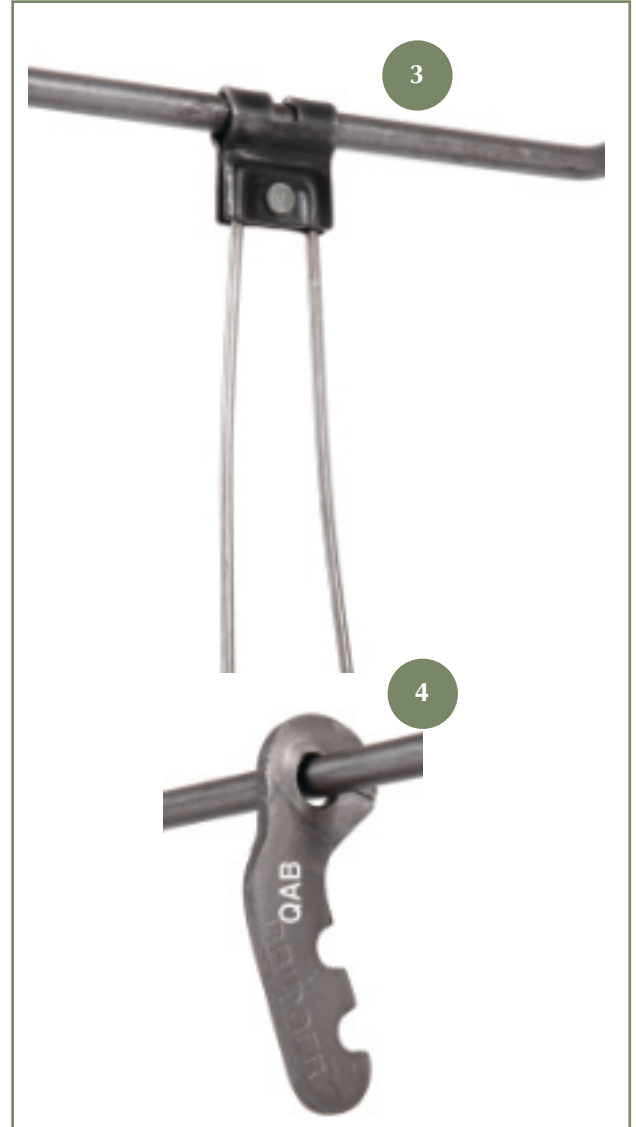
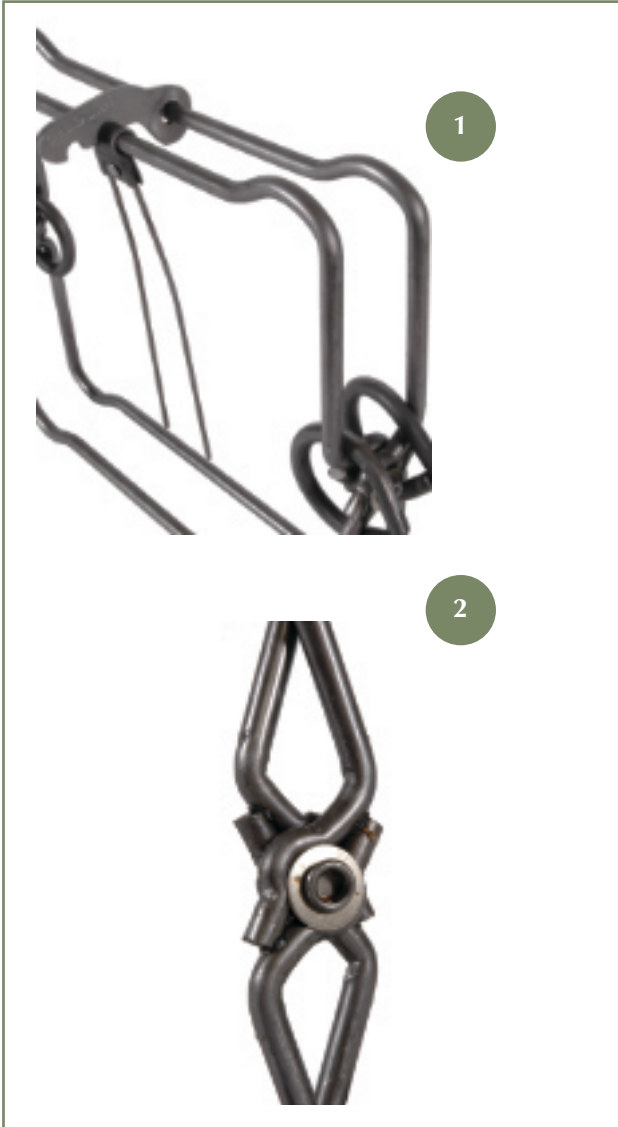



Certified trap identification sheet

DUKE

JANUARY 2024

SET TRAP



CLOSED TRAP

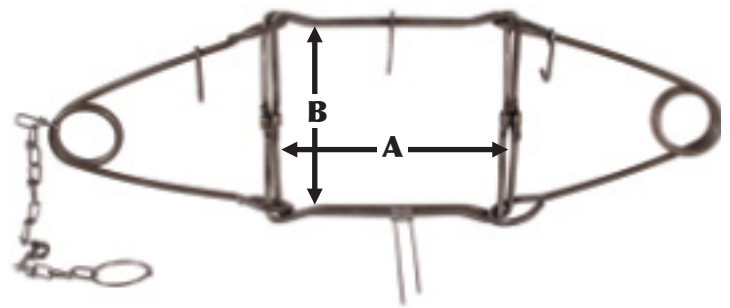

MODEL	AIHTS CERTIFICATION		INSIDE MEASUREMENT TAKEN ON THE SAME JAW (CLOSED TRAP)	
	NUMBER	TARGET SPECIES	WIDTH (A)	HEIGHT (B)
110 1 SPRING		Muskrat (underwater)	4 ³ / ₈ inch (111 mm)	4 ³ / ₈ inch (111 mm)
110 MAGNUM		Muskrat (underwater)	4 ¹ / ₄ inch (109 mm)	4 ³ / ₈ inch (111 mm)
120	QAG	Muskrat (underwater + on land)	4 ³ / ₈ inch (111 mm)	4 ³ / ₈ inch (111 mm)
160	QRL	Muskrat (underwater), Raccoon	5 ⁷ / ₈ inch (149 mm)	5 ⁷ / ₈ inch (149 mm)
220	QRK	Muskrat (underwater), Raccoon	7 ³ / ₄ inch (197 mm)	6 ¹ / ₈ inch (155 mm)
280	QCO	Muskrat (underwater), Beaver Canada Lynx, Bobcat	7 ⁷ / ₈ inch (200 mm)	8 ¹ / ₄ inch (210 mm)
330	QCJ	Muskrat (underwater), Beaver	10 ¹ / ₂ inch (267 mm)	8 ³ / ₈ inch (213 mm)

Certified trap identification sheet

JANUARY 2024

LOCATION OF THE CERTIFICATION NUMBER



Commercial name of trap :

DUKE

CLOSED TRAP

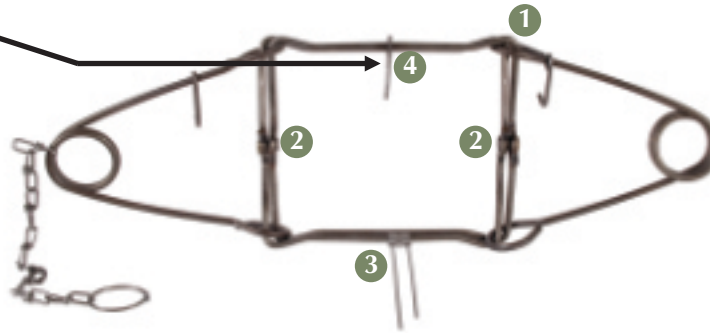

CHARACTERISTICS

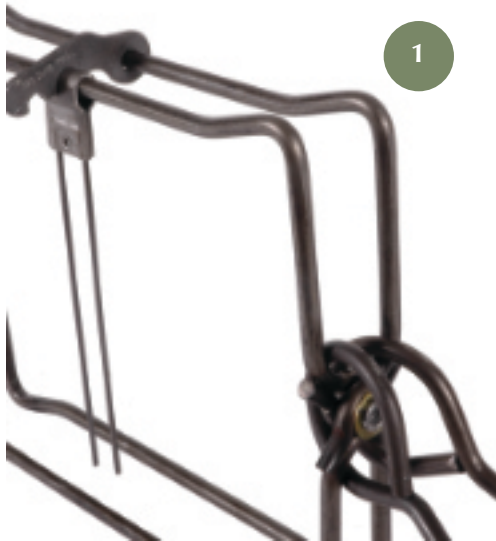



Certified trap identification sheet

CONV
(Netherlands)

JANUARY 2024

SET TRAP



CLOSED TRAP

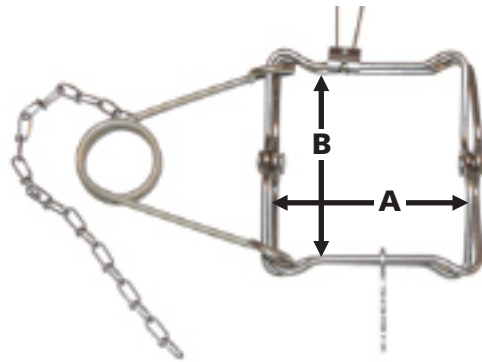

MODEL	AIHTS CERTIFICATION		INSIDE MEASUREMENT TAKEN ON THE SAME JAW (CLOSED TRAP)	
	NUMBER	TARGET SPECIES	(A)	(B)
110-CAN (STAINLESS STEEL)	AAE	Muskrat (underwater + on land)	4 ⁵ / ₈ inch (119 mm)	4 ⁵ / ₈ inch (117 mm)



Certified trap identification sheet

EIABZUGSEISEN (Germany)

JANUARY 2024

SET TRAP

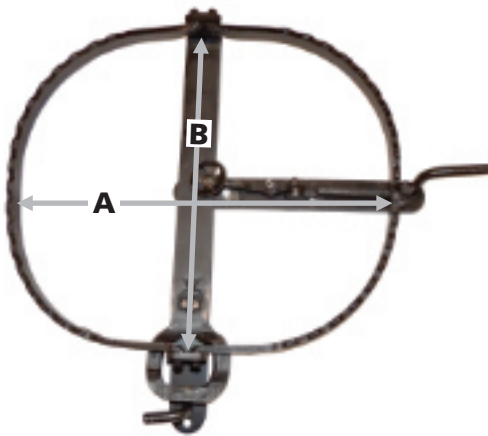

CLOSED TRAP



MODEL	AIHTS CERTIFICATION		INSIDE MEASUREMENT TAKEN ON THE SET TRAP	
	NUMBER	TARGET SPECIES	(A)	(B)
EIABZUGSEISEN	QMF	Martens	14 ³ / ₈ inch (365 mm)	12 inch (305 mm)

NOTE:

Trap model currently prohibited in many Canadian jurisdictions. Refer to applicable trapping regulations to confirm its legal use.



Certified trap identification sheet

**FMB + FS
(Netherlands)**

JANUARY 2024

SET TRAP

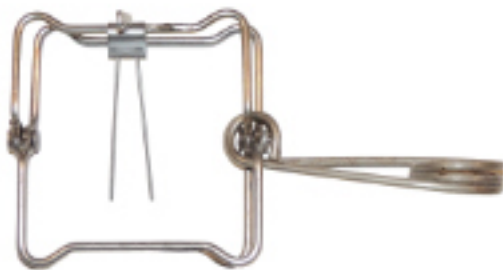

CLOSED TRAP

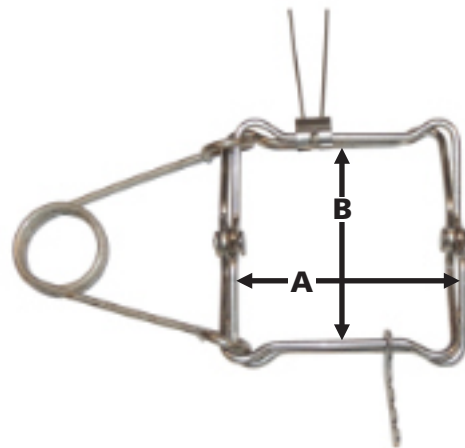

MODEL	AIHTS CERTIFICATION		INSIDE MEASUREMENT TAKEN ON THE SAME JAW (CLOSED TRAP)	
	NUMBER	TARGET SPECIES	(A)	(B)
FMB-110-SS (STAINLESS STEEL)	AAD	Muskrat (underwater + on land)	4 ⁵ / ₈ inch (118 mm)	4 ¹ / ₂ inch (115 mm)
FMB-150-SS (STAINLESS STEEL)	AAF	Muskrat (underwater + on land)	6 inch (152 mm)	6 ¹ / ₁₆ inch (154 mm)
FS-110-SS (STAINLESS STEEL)	QAR	Muskrat (underwater + on land)	4 ⁵ / ₈ inch (118 mm)	4 ¹ / ₂ inch (116 mm)



Certified trap identification sheet

HZ
(Netherlands)

JANUARY 2024

SET TRAP



CLOSED TRAP

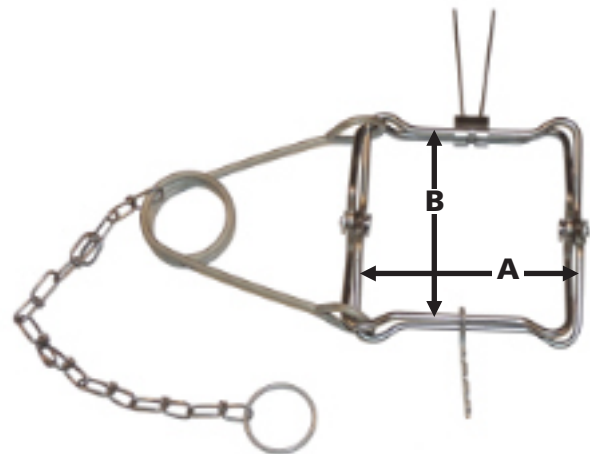

MODEL	AIHTS CERTIFICATION		INSIDE MEASUREMENT TAKEN ON THE SAME JAW (CLOSED TRAP)	
	NUMBER	TARGET SPECIES	(A)	(B)
110-SS (STAINLESS STEEL)	QAO	Muskrat (underwater + on land)	4 ¹¹ / ₁₆ inch (119 mm)	4 ¹ / ₂ inch (115 mm)



Certified trap identification sheet

KLEINER SCHWANENHALS (Germany)

JANUARY 2024

SET TRAP

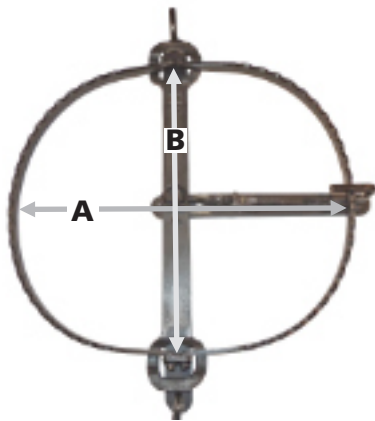

CLOSED TRAP



MODEL	AIHTS CERTIFICATION		INSIDE MEASUREMENT TAKEN ON THE SET TRAP	
	NUMBER	TARGET SPECIES	(A)	(B)
KLEINER SCHWANENHALS	QME	Martens	17 ³ / ₄ inch (452 mm)	15 ¹ / ₄ inch (388 mm)

NOTE:

Trap model currently prohibited in many Canadian jurisdictions. Refer to applicable trapping regulations to confirm its legal use.



Certified trap identification sheet

KT-140
(Russia)

JANUARY 2024

SET TRAP



CLOSED TRAP

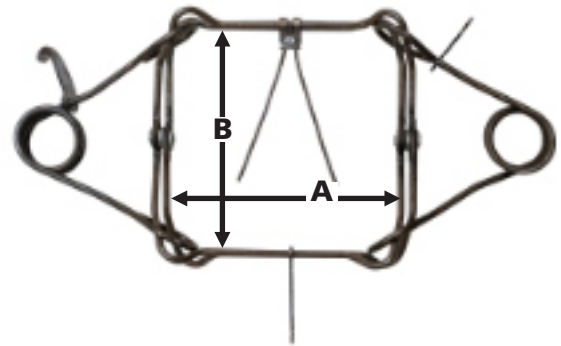

MODEL	AIHTS CERTIFICATION		INSIDE MEASUREMENT TAKEN ON THE SAME JAW (CLOSED TRAP)	
	NUMBER	TARGET SPECIES	(A)	(B)
KT-140	QED	Muskrat (underwater + on land), Weasel	5 ³ / ₄ inch (145 mm)	6 ¹ / ₁₆ inch (154 mm)



Certified trap identification sheet

KORO

JANUARY 2024

KORO MUSKRAT



CLOSED TRAP

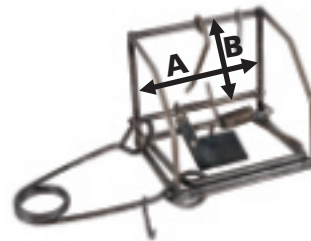

KORO RODENT

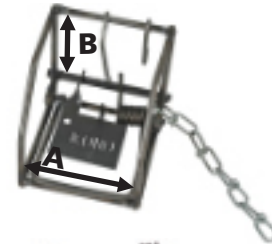

KORO NO 1 et 2

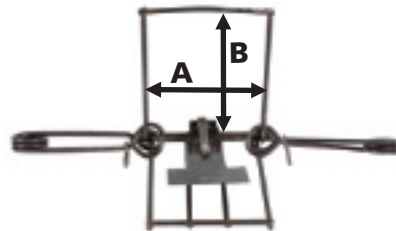

AIHTS CERTIFICATION

INSIDE MEASUREMENT TAKEN ON THE JAW

MODEL	AIHTS CERTIFICATION		INSIDE MEASUREMENT TAKEN ON THE JAW	
	NUMBER	TARGET SPECIES	WIDTH (A)	HEIGHT (B)
MUSKRAT	MAA MWB	Muskrat (underwater + on land), Weasel	4 ⁷ / ₈ inch (125 mm)	3 ³ / ₈ inch (85 mm)
N° 1	MMA	Muskrat (underwater), Martens	6 ¹ / ₈ inch (155 mm)	6 ³ / ₄ inch (172 mm)
N° 2	MFA	Muskrat (underwater), Fisher, Raccoon, Martens	6 ¹ / ₈ inch (155 mm)	7 ³ / ₄ inch (197 mm)
RODENT	MWA	Muskrat (underwater), Weasel	3 ¹ / ₈ inch (80 mm)	2 ³ / ₄ inch (70 mm)
LARGE RODENT DOUBLE SPRING	MAB	Muskrat (underwater + on land), Weasel	5 inch (127 mm)	3 ³ / ₄ inch (95 mm)

Commercial name of trap :
KORO

KORO MUSKRAT + RODENT



KORO NO 1 AND 2



LOCATION OF THE
CERTIFICATION NUMBER



Certified trap identification sheet

LDL, "B" and "C MAGNUM" SERIES

JANUARY 2024

SET TRAP



CLOSED TRAP

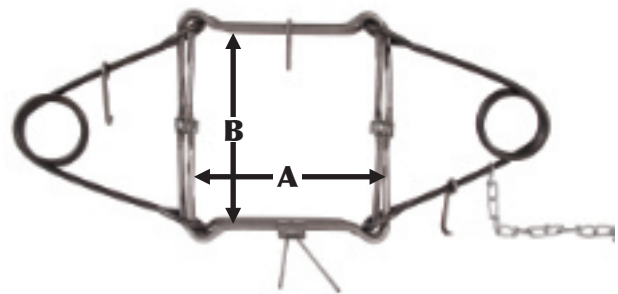

MODEL	AIHTS CERTIFICATION		INSIDE MEASUREMENT TAKEN ON THE SAME JAW (CLOSED TRAP)	
	NUMBER	TARGET SPECIES	WIDTH (A)	HEIGHT (B)
B120	QAL	Muskrat (underwater + on land)	4 ³ / ₄ inch (121 mm)	4 ¹³ / ₁₆ inch (123 mm)
B120 MAGNUM	OMA	Muskrat (underwater + on land), Martens, Weasel	4 ³ / ₄ inch (121 mm)	4 ³ / ₄ inch (121 mm)
C160 MAGNUM	OPA	Muskrat (underwater), Fisher, Raccoon, Martens	6 ¹ / ₁₆ inch (154 mm)	6 inch (152 mm)
C220 MAGNUM	QPA	Muskrat (underwater), Raccoon, Fisher, Otter, Canada Lynx, Bobcat	7 ¹ / ₁₆ inch (180 mm)	7 inch (178 mm)
C280 MAGNUM	QCK	Muskrat (underwater), Beaver, Otter, Raccoon, Canada Lynx, Bobcat	8 ⁹ / ₁₆ inch (220 mm)	8 inch (203 mm)
C330 MAGNUM	QCL	Muskrat (underwater), Beaver, Canada Lynx, Bobcat	10 ³ / ₈ inch (264 mm)	9 ¹³ / ₁₆ inch (250 mm)

LOCATION OF THE
CERTIFICATION NUMBER

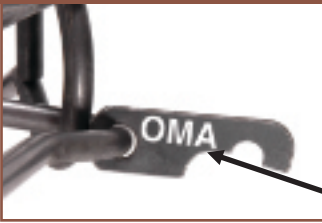

Commercial name of trap :
LDL, "B" and "C MAGNUM" SERIES

CLOSED TRAP

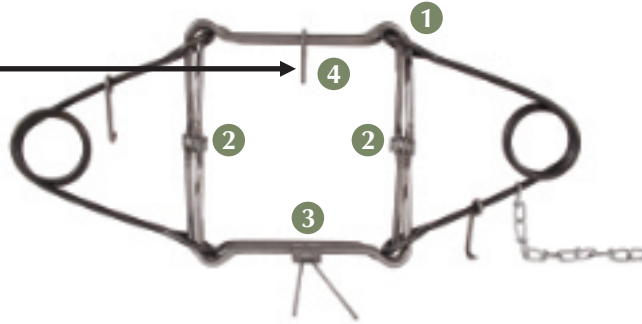

CHARACTERISTICS





Certified trap identification sheet

LDL, "C" SERIES

JANUARY 2024

SET TRAP



CLOSED TRAP

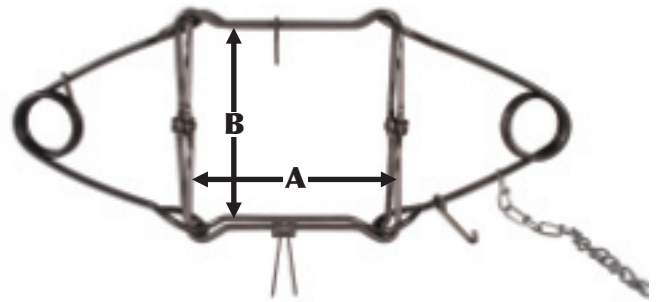

MODEL	AIHTS CERTIFICATION		INSIDE MEASUREMENT TAKEN ON THE SAME JAW (CLOSED TRAP)	
	NUMBER	TARGET SPECIES	WIDTH (A)	HEIGHT (B)
C110 1 SPRING		Muskrat (underwater)	4 ³ / ₄ inch (121 mm)	4 ¹³ / ₁₆ inch (123 mm)
C120		Muskrat (underwater)	4 ³ / ₄ inch (121 mm)	4 ¹³ / ₁₆ inch (123 mm)
C160	ORA	Muskrat (underwater), Raccoon	6 ¹ / ₁₆ inch (154 mm)	6 ¹ / ₁₆ inch (154 mm)
C220	ORB	Muskrat (underwater), Raccoon, Otter, Canada Lynx, Bobcat	7 ¹ / ₁₆ inch (180 mm)	7 ¹ / ₁₆ inch (180 mm)
C280	OCA	Muskrat (underwater), Beaver	8 ⁹ / ₁₆ inch (220 mm)	8 ³ / ₁₆ inch (208 mm)
C330	OCB	Muskrat (underwater), Beaver, Canada Lynx, Bobcat	10 ³ / ₈ inch (264 mm)	9 ¹³ / ₁₆ inch (250 mm)

LOCATION OF THE
CERTIFICATION NUMBER



Commercial name of trap :
LDL, "C" SERIES

CLOSED TRAP

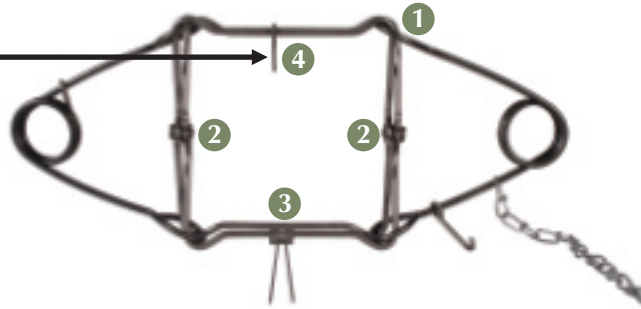

CHARACTERISTICS

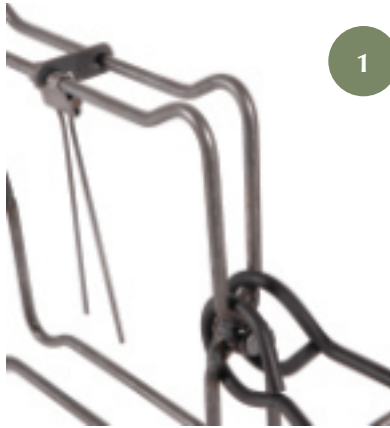

1



2



3



4



Certified trap identification sheet

OUELL

JANUARY 2024

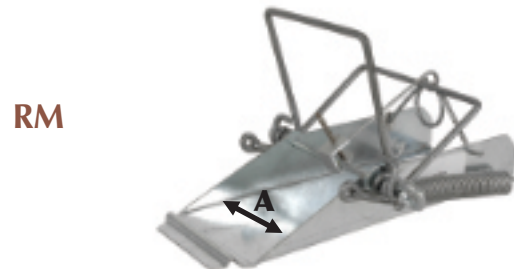
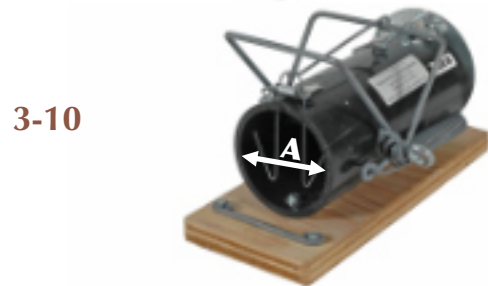
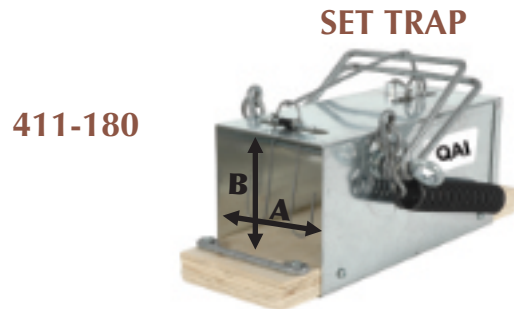

MODEL	AIHTS CERTIFICATION		INSIDE MEASUREMENT	
	NUMBER	TARGET SPECIES	WIDTH (A)	HEIGHT (B)
411-180	QAI	Muskrat (underwater + on land), Weasel	3 1/2 inch (90 mm)	3 inch (77 mm)
3-10	QEB	Muskrat (underwater), Weasel	3 inch (75 mm)	
RM	QED	Muskrat (underwater + on land), Weasel	3 1/2 inch (90 mm)	

Certified trap identification sheet

JANUARY 2024

Commercial name of trap :

OUELL

411-180 / 3-10

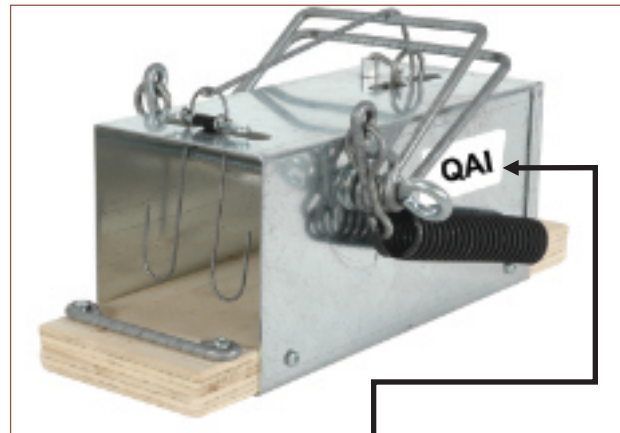

**LOCATION OF THE
CERTIFICATION NUMBER**



Certified trap identification sheet

RUDY

JANUARY 2024

SET TRAP



CLOSED TRAP

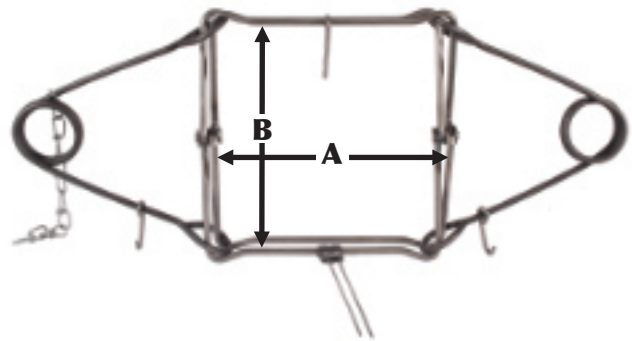

MODEL	AIHTS CERTIFICATION		INSIDE MEASUREMENT TAKEN ON THE SAME JAW (CLOSED TRAP)	
	NUMBER	TARGET SPECIES	WIDTH (A)	HEIGHT (B)
110 1 SPRING	QAH	Muskrat (underwater + on land)	4 1/4 inch (109 mm)	4 1/4 inch (109 mm)
120	QAJ	Muskrat (underwater + on land)	4 1/4 inch (109 mm)	4 1/4 inch (109 mm)
120 MAG.	QMD	Muskrat (underwater + on land), Martens, Fisher, Weasel	4 1/4 inch (109 mm)	4 1/4 inch (109 mm)
160	QRH	Muskrat (underwater), Raccoon	5 3/4 inch (146 mm)	6 inch (152 mm)
160 PLUS.	QPB	Muskrat (underwater), Fisher, Martens, Raccoon	5 7/8 inch (150 mm)	6 1/4 inch (158 mm)
220	QRD	Muskrat (underwater), Raccoon	7 inch (178 mm)	7 1/8 inch (181 mm)
220 PLUS	QRO	Muskrat (underwater), Fisher, Raccoon, Otter	7 inch (178 mm)	7 inch (178 mm)
280	QCE	Muskrat (underwater), Beaver, Otter	8 1/8 inch (207 mm)	8 1/8 inch (207 mm)
330	QCB	Muskrat (underwater), Beaver, Ot- ter, Canada Lynx, Bobcat	10 inch (254 mm)	10 1/4 inch (260 mm)

Certified trap identification sheet

JANUARY 2024

LOCATION OF THE CERTIFICATION NUMBER

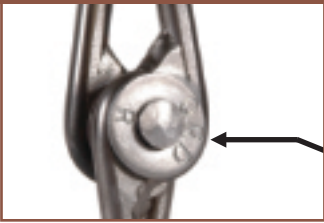

Commercial name of trap :

RUDY

CLOSED TRAP

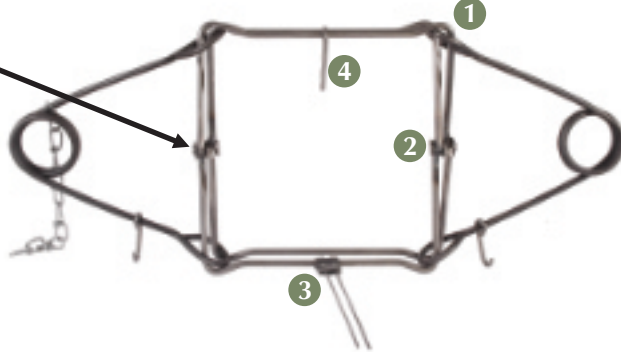

CHARACTERISTICS

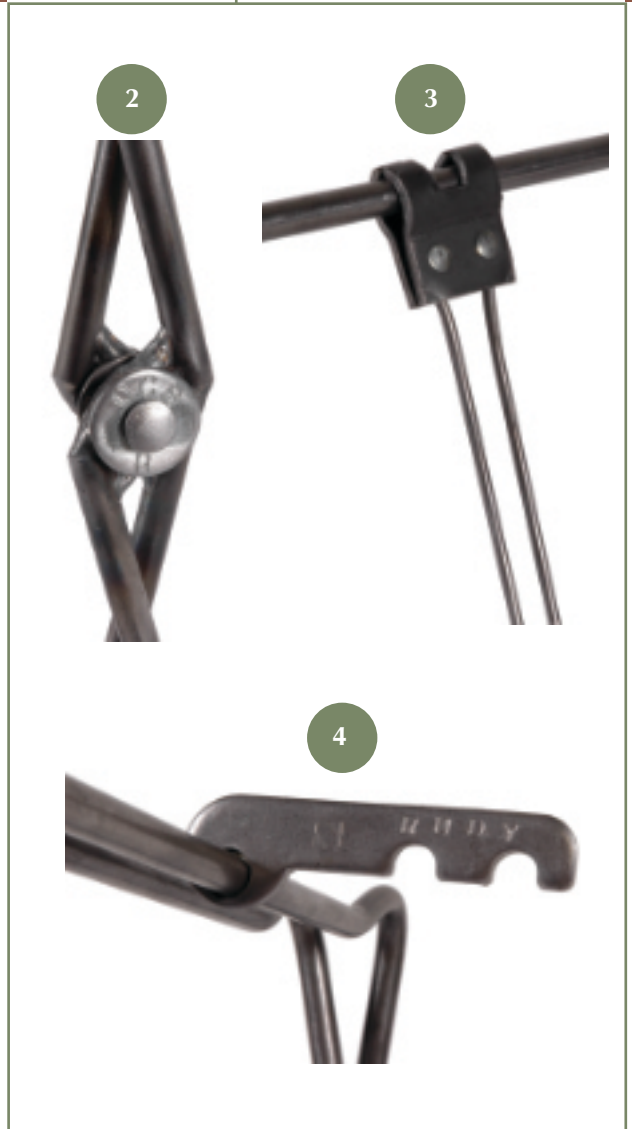
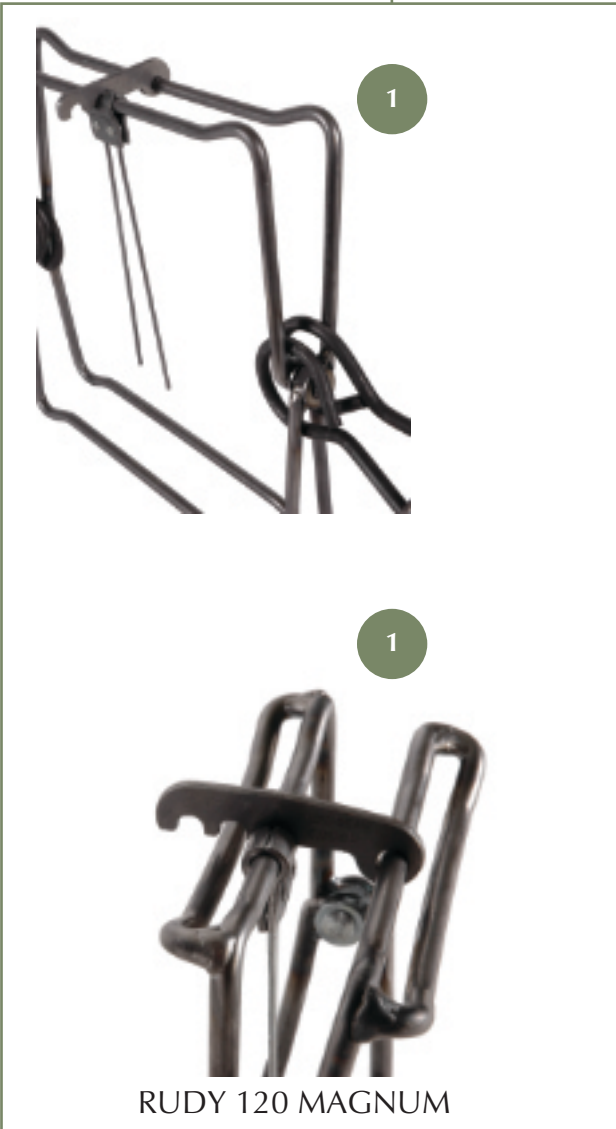



Certified trap identification sheet

SAUVAGEAU 1000-11 F

JANUARY 2024

SET TRAP



CLOSED TRAP

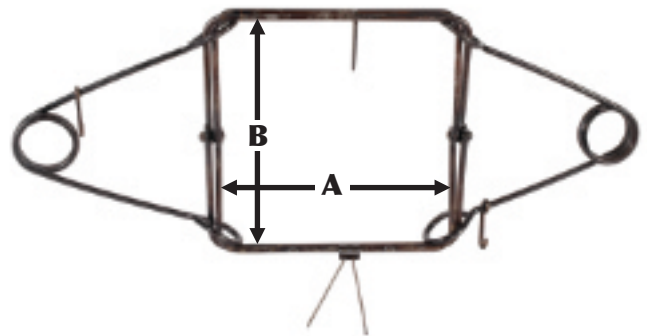

MODEL	AIHTS CERTIFICATION		INSIDE MEASUREMENT TAKEN ON THE SAME JAW (CLOSED TRAP)	
	NUMBER	TARGET SPECIES	WIDTH (A)	HEIGHT (B)
1000-11 F	QCD	Muskrat (underwater), Beaver	11 inch (280 mm)	11 inch (280 mm)

LOCATION OF THE
CERTIFICATION NUMBER



Commercial name of trap :

SAUVAGEAU 1000-11 F

CLOSED TRAP

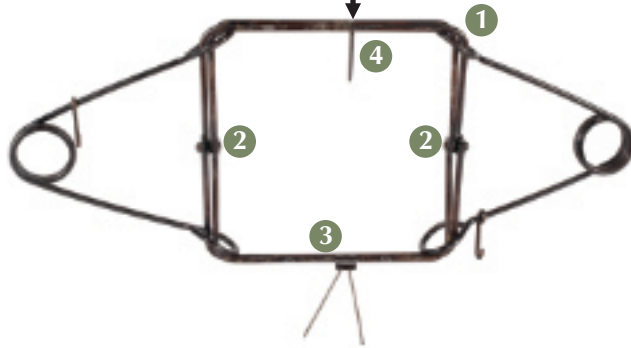

CHARACTERISTICS

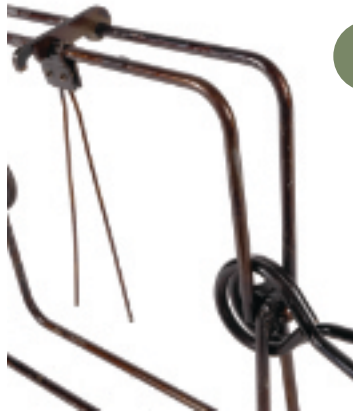

1



2



3



4



Certified trap identification sheet

SAUVAGEAU, "2001" SERIES

JANUARY 2024

SET TRAP



CLOSED TRAP

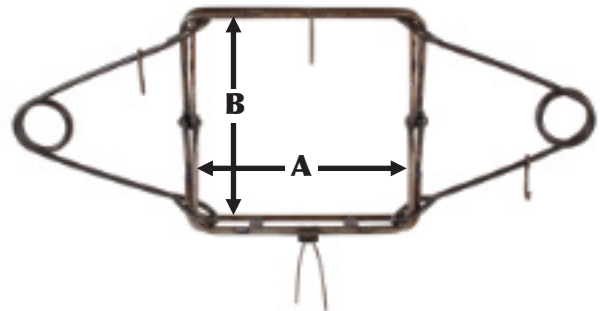

MODEL	AIHTS CERTIFICATION		INSIDE MEASUREMENT TAKEN ON THE SAME JAW (CLOSED TRAP)	
	NUMBER	TARGET SPECIES	WIDTH (A)	HEIGHT (B)
2001-5	QMA	Muskrat (underwater + on land), Martens, Fisher, Weasel	4 1/2 inch (114 mm)	5 inch (128 mm)
2001-6	QRA	Muskrat (underwater), Raccoon, Fisher, Marten	6 inch (152 mm)	6 inch (152 mm)
2001-7	QRB	Muskrat (underwater), Raccoon, Fisher	7 inch (178 mm)	7 inch (178 mm)
2001-8	QRC	Muskrat (underwater), Raccoon, Fisher, Beaver, Otter, Canada Lynx, Bobcat	8 1/2 inch (216 mm)	8 inch (203 mm)
2001-11	QCA	Muskrat (underwater), Beaver, Otter, Canada Lynx, Bobcat	11 inch (280 mm)	11 inch (280 mm)
2001-12	QCM	Muskrat (underwater), Beaver, Otter	12 inch (305 mm)	11 inch (280 mm)

LOCATION OF THE
CERTIFICATION NUMBER



Commercial name of trap :
SAUVAGEAU, "2001" SERIES

CLOSED TRAP

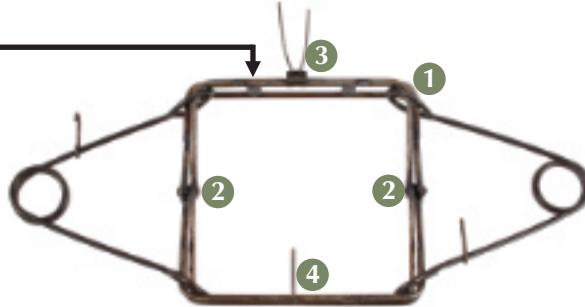

CHARACTERISTICS





Certified trap identification sheet

SAUVAGEAU C120 MAGNUM

JANUARY 2024

SET TRAP



CLOSED TRAP

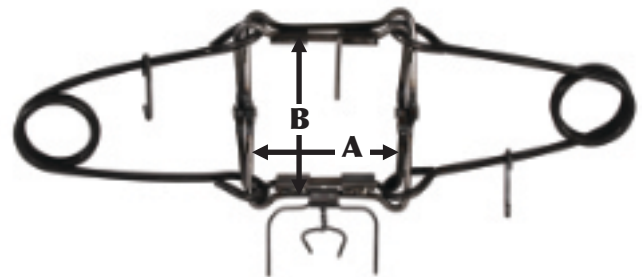

MODEL	AIHTS CERTIFICATION		INSIDE MEASUREMENT TAKEN ON THE SAME JAW (CLOSED TRAP)	
	NUMBER	TARGET SPECIES	WIDTH (A)	HEIGHT (B)
C120 MAGNUM	QMB	Muskrat (underwater + on land), Martens, Weasel	4 1/2 inch (114 mm)	5 inch (128 mm)

LOCATION OF THE
CERTIFICATION NUMBER



Commercial name of trap :
SAUVAGEAU C120 MAGNUM

CLOSED TRAP

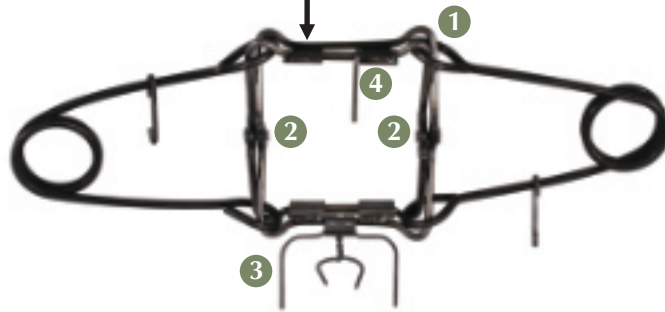

CHARACTERISTICS

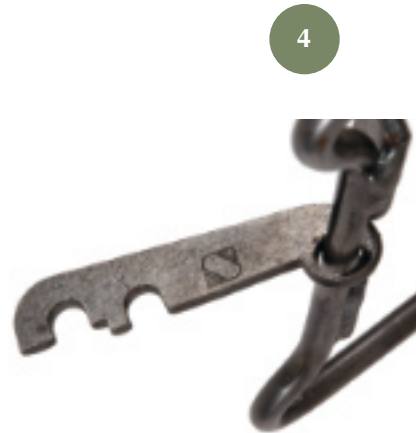
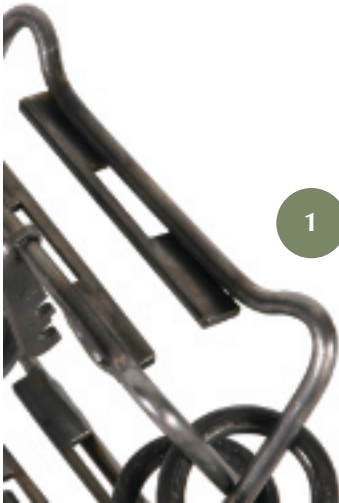



Certified trap identification sheet

SAUVAGEAU C120, "REVERSE BEND"

JANUARY 2024

SET TRAP



CLOSED TRAP

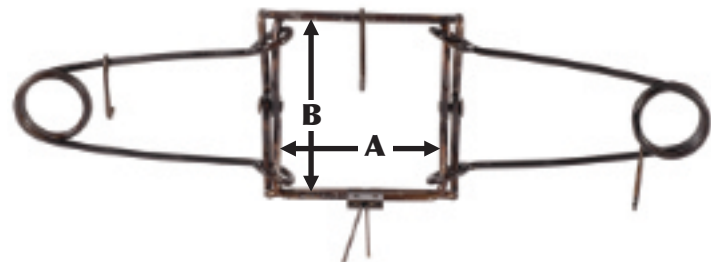

MODEL	AIHTS CERTIFICATION		INSIDE MEASUREMENT TAKEN ON THE SAME JAW (CLOSED TRAP)	
	NUMBER	TARGET SPECIES	WIDTH (A)	HEIGHT (B)
C120	QAF	Muskrat (underwater + on land), Weasel	4 1/2 inch (114 mm)	4 1/2 inch (114 mm)

Commercial name of trap :
SAUVAGEAU C120, "REVERSE BEND"

CLOSED TRAP

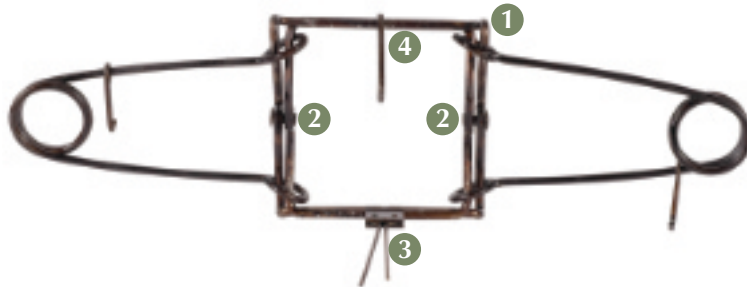

CHARACTERISTICS





Certified trap identification sheet

SPECIES SPECIFIC DISLOCATOR HALF MAGNUM

JANUARY 2024

SET TRAP



CLOSED TRAP

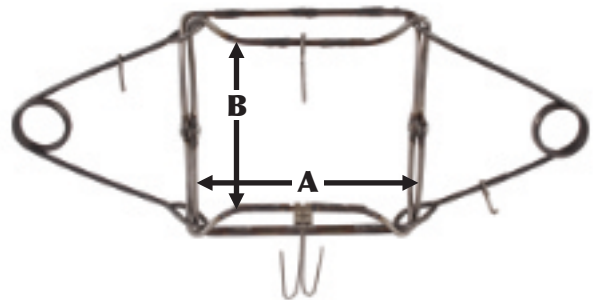

MODEL	AIHTS CERTIFICATION		INSIDE MEASUREMENT TAKEN ON THE SAME JAW (CLOSED TRAP)	
	NUMBER	TARGET SPECIES	WIDTH (A)	HEIGHT (B)
220	QRI	Muskrat (underwater), Raccoon	6 inch (152 mm)	7 inch (178 mm)
330	QCH	Muskrat (underwater), Beaver	9 inch (228 mm)	10 inch (254 mm)
440	QCI	Muskrat (underwater), Beaver	12 inch (305 mm)	9 inch (228 mm)

Commercial name of trap :
**SPECIES SPECIFIC DISLOCATOR
HALF MAGNUM**

CLOSED TRAP

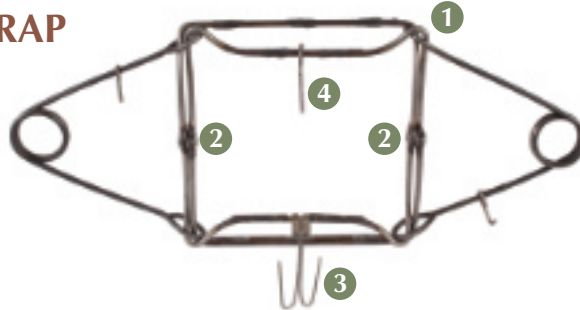

CHARACTERISTICS





Certified trap identification sheet

TRIPLE M

JANUARY 2024

SET TRAP

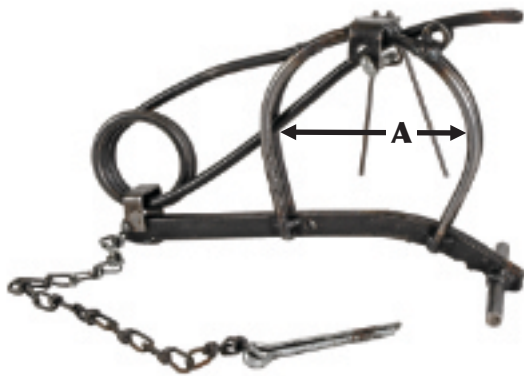

CLOSED TRAP



AIHTS CERTIFICATION

NUMBER	TARGET SPECIES	INSIDE MEASUREMENT (A) TAKEN ON THE SET TRAP
QAC	Muskrat (underwater + on land), Weasel	4 ¹ / ₁₆ inch (103 mm)



Certified trap identification sheet

VICTOR

JANUARY 2024

SET TRAP

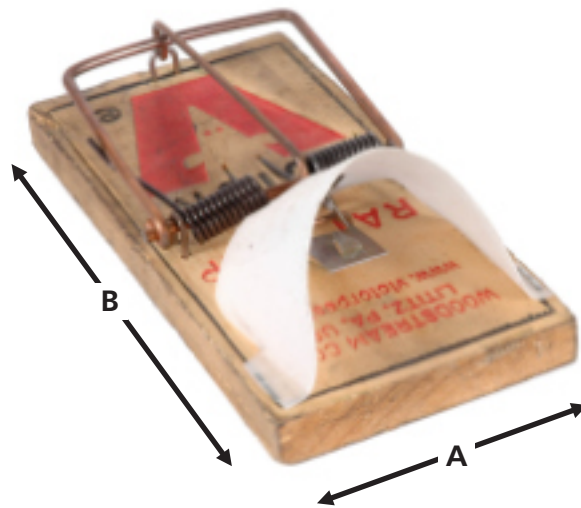

AIHTS CERTIFICATION

MODEL	NUMBER	TARGET SPECIES	WIDTH (A)	HEIGHT (B)
RAT TRAP	QEA	Weasel	3 1/4 inch (83 mm)	7 inch (178 mm)



Certified trap identification sheet

WOODSTREAM ONEIDA VICTOR CONIBEAR

JANUARY 2024

SET TRAP



CLOSED TRAP

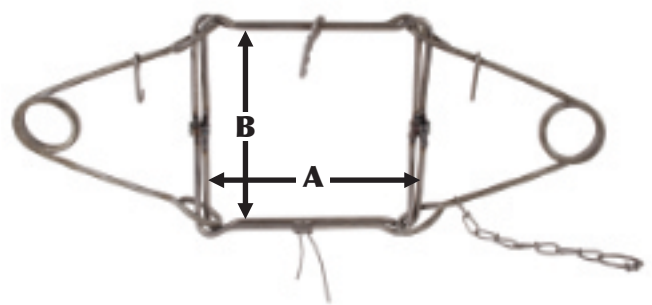

MODEL	AIHTS CERTIFICATION		INSIDE MEASUREMENT TAKEN ON THE SAME JAW (CLOSED TRAP)	
	NUMBER	TARGET SPECIES	WIDTH (A)	HEIGHT (B)
CONIBEAR 110 1 SPRING	QAA	Muskrat (underwater + on land), Weasel	4 ³ / ₄ inch (121 mm)	4 ⁵ / ₈ inch (120 mm)
CONIBEAR 120	OAA	Muskrat (underwater + on land), Weasel	4 ³ / ₄ inch (121 mm)	4 ⁵ / ₈ inch (120 mm)
CONIBEAR 160	ORE	Muskrat (underwater), Raccoon	6 inch (152 mm)	6 inch (152 mm)
CONIBEAR 220	ORC	Muskrat (underwater), Raccoon, Ot- ter	7 inch (178 mm)	6 ⁷ / ₈ inch (175 mm)
CONIBEAR 280	OCE	Muskrat (underwater), Beaver, Otter	8 ³ / ₈ inch (213 mm)	8 ³ / ₈ inch (213 mm)
CONIBEAR 330	OCC	Muskrat (underwater), Beaver, Canada Lynx, Otter, Bobcat	10 ³ / ₈ inch (264 mm)	9 ³ / ₄ inch (248 mm)

LOCATION OF THE
CERTIFICATION NUMBER

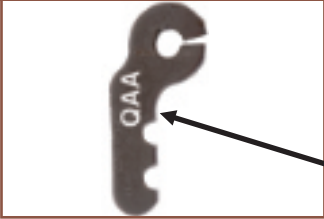

Commercial name of trap :
**WOODSTREAM ONEIDA
VICTOR CONIBEAR**

CLOSED TRAP

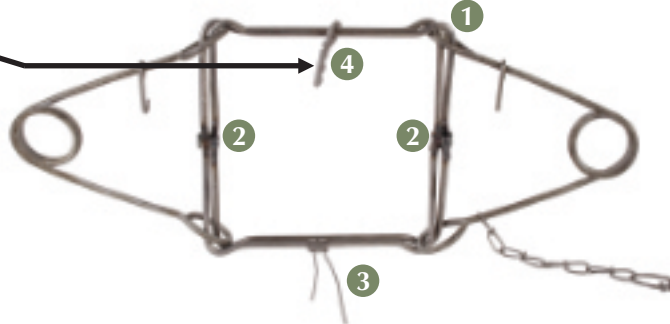

CHARACTERISTICS



1



2



3



4



Certified trap identification sheet

WOODSTREAM ONEIDA VICTOR "NORTHWOODS"

JANUARY 2024

SET TRAP



CLOSED TRAP

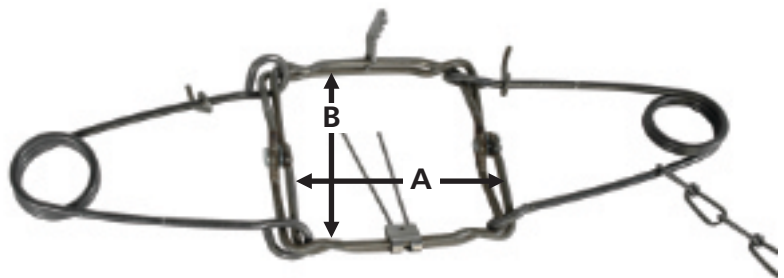

MODEL	AIHTS CERTIFICATION		INSIDE MEASUREMENT TAKEN ON THE SAME JAW (CLOSED TRAP)	
	NUMBER	TARGET SPECIES	WIDTH (A)	HEIGHT (B)
NORTHWOODS 155	QRN	Muskrat (underwater), Raccoon, Martens	4 ³ / ₄ inch (121 mm)	5 ¹ / ₈ inch (130 mm)

Commercial name of trap :
**WOODSTREAM ONEIDA VICTOR
"NORTHWOODS"**

LOCATION OF THE
CERTIFICATION NUMBER



CLOSED TRAP

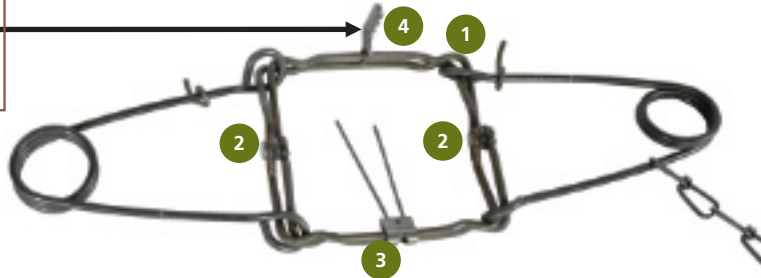

CHARACTERISTICS

1



2



3



4





Certified trap identification sheet

WOODSTREAM ONEIDA VICTOR CONIBEAR « STAINLESS STEEL »

JANUARY 2024

SET TRAP



CLOSED TRAP

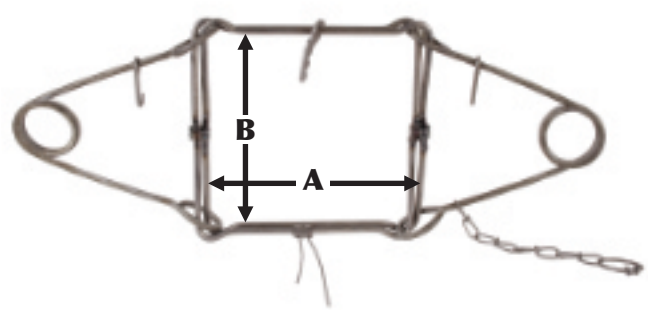

MODEL	AIHTS CERTIFICATION		INSIDE MEASUREMENT TAKEN ON THE SAME JAW (CLOSED TRAP)	
	NUMBER	TARGET SPECIES	WIDTH (A)	HEIGHT (B)
120 STAINLESS STEEL	AAA	Muskrat (underwater + on land)	4 1/2 inch (114 mm)	4 5/8 inch (120 mm)
110-3 STAINLESS STEEL	QAM	Muskrat (underwater + on land)	4 3/4 inch (121 mm)	4 3/4 inch (121 mm)
110-3 STAINLESS STEEL MAGNUM	QAN	Muskrat (underwater + on land)	4 3/4 inch (121 mm)	4 7/8 inch (125 mm)
120-3 STAINLESS STEEL	QAP	Muskrat (underwater + on land)	4 3/4 inch (121 mm)	4 3/4 inch (121 mm)
120-3 STAINLESS STEEL MAGNUM	QAQ	Muskrat (underwater + on land), Martens	4 3/4 inch (121 mm)	4 7/8 inch (125 mm)
C-220 STAINLESS STEEL	QRP	Muskrat (underwater), Raccoon	7 inch (177 mm)	6 7/8 inch (174 mm)



Certified trap identification sheet

WCS "TUBE TRAP INT'L"

JANUARY 2024

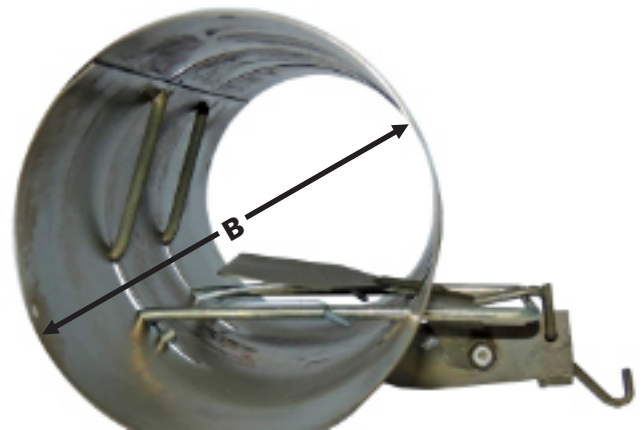
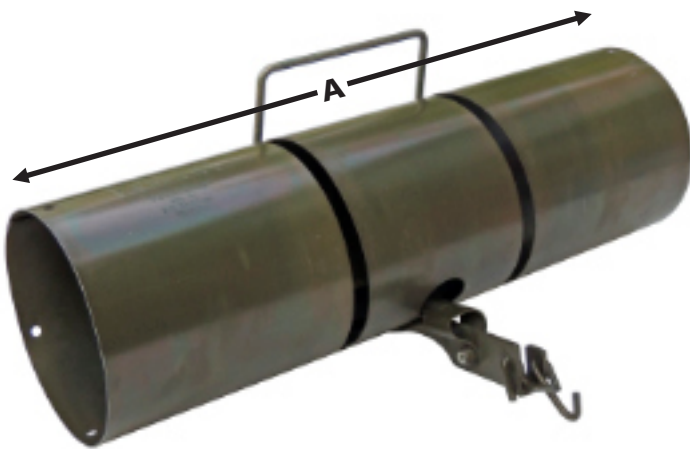

MODEL	AIHTS CERTIFICATION		MEASUREMENTS	
	NUMBER	TARGET SPECIES	LENGTH (A)	DIAMETER (B)
TUBE TRAP	VEA	Muskrat (underwater + on land), Weasel	15 inch (380 mm)	4 1/2 inch (115 mm)
SHORTY	VEB	Muskrat (underwater + on land), Weasel	7 1/2 inch (190 mm)	4 1/2 inch (115 mm)

Chapter 2
LIVE CAPTURE TRAPS



Certified trap identification sheet

BELISLE FOOTSNARE

JANUARY 2024

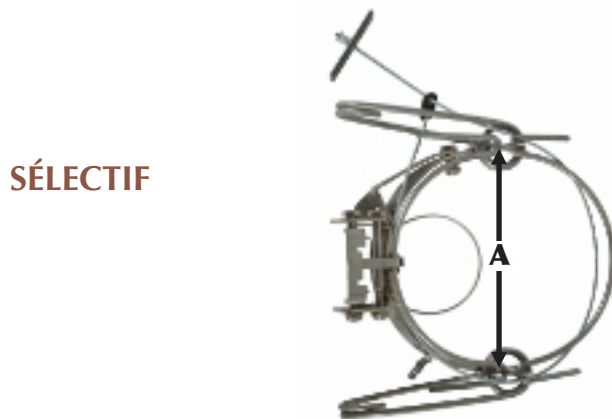
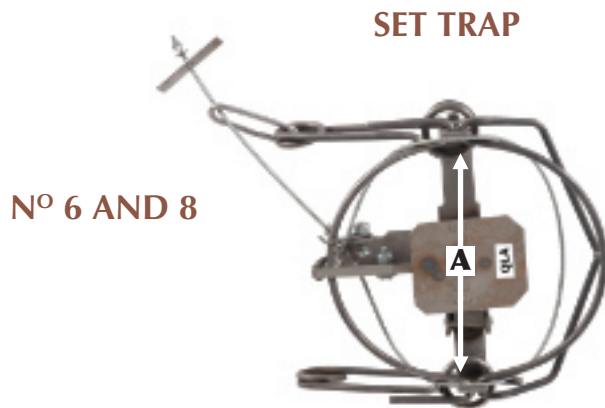

AIHTS CERTIFICATION

MODEL	NUMBER	TARGET SPECIES	INSIDE MEASUREMENT (A) TAKEN ON THE SET TRAP
N° 6	QLA	Canada Lynx, Coyote, Bobcat, Red fox	5 ³ / ₄ inch (148 mm)
N° 8	QWA	Wolf	7 ³ / ₄ inch (197 mm)
SÉLECTIF	QYB	Canada Lynx, Coyote, Bobcat, Red fox	5 ³ / ₄ inch (148 mm)

Commercial name of trap :

BELISLE FOOTSNARE



LOCATION OF THE
CERTIFICATION NUMBER



Certified trap identification sheet

BEER

JANUARY 2024

CLOSED TRAP

JAW OFFSET WIDTH:
3/8 INCH (10.2 mm)

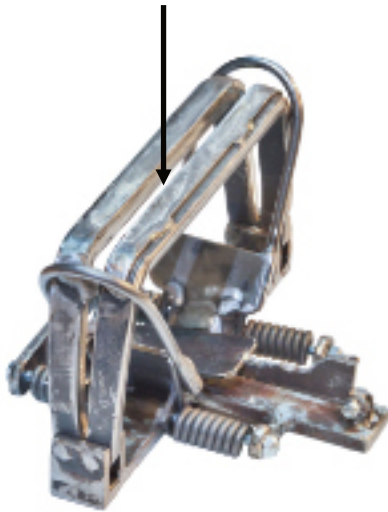

SET TRAP

JAW THICKNESS:
1/2 INCH (13 mm)

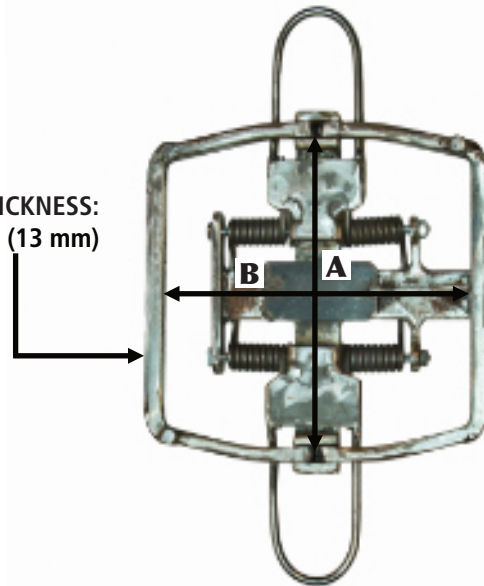

MODEL	AIHTS CERTIFICATION		INSIDE MEASUREMENT TAKEN ON THE SET TRAP	
	NUMBER	TARGET SPECIES	(A)	(B)
BFV N° 1 PLUS	AWB	Wolf	7 3/4 inch (198 mm)	8 1/4 inch (210 mm)



Certified trap identification sheet

BREATHE EASY

JANUARY 2024

SET TRAP

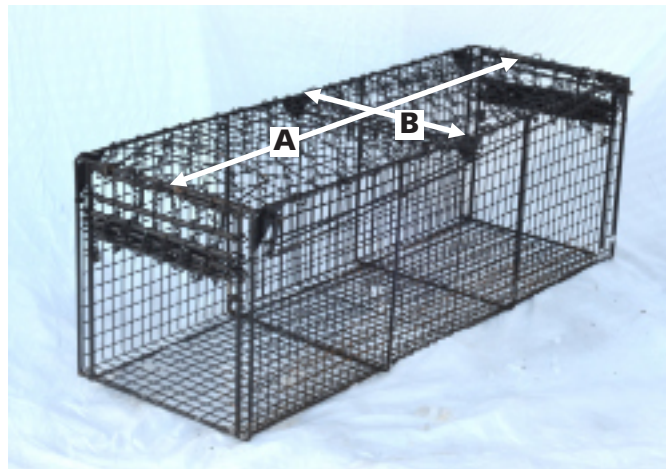

MODEL	AIHTS CERTIFICATION		MEASUREMENTS	
	NUMBER	TARGET SPECIES	(A)	(B)
«BREATHE EASY» LIVE BEAVER TRAP	VCE	Beaver	48 inch (122 cm)	16.5 inch (42 cm)



Certified trap identification sheet

BRIDGER ALASKAN NO 5

JANUARY 2024

CLOSED TRAP



OFFSET, LAMINATED



RUBBER JAWS

SET TRAP



MODEL	AIHTS CERTIFICATION		INSIDE MEASUREMENT TAKEN ON THE SET TRAP	
	NUMBER	TARGET SPECIES	(A)	(B)
OFFSET, LAMINATED	QWE	Wolf	7 inch (176 mm)	7 1/8 inch (180 mm)
RUBBER JAWS	QWF	Wolf	6 7/8 inch (175 mm)	6 7/8 inch (175 mm)



Certified trap identification sheet

BRIDGER BRAWN

JANUARY 2024

CLOSED TRAP



SET TRAP



MODEL	AIHTS CERTIFICATION		INSIDE MEASUREMENT TAKEN ON THE SET TRAP	
	NUMBER	TARGET SPECIES	(A)	(B)
N° 9 RUBBER JAWS	AWA	Wolf	7 1/2 inch (190 mm)	8 1/16 inch (205 mm)



Certified trap identification sheet

BRIDGER "COIL SPRINGS" OFFSET + LAMINATED JAWS

JANUARY 2024

SET TRAP

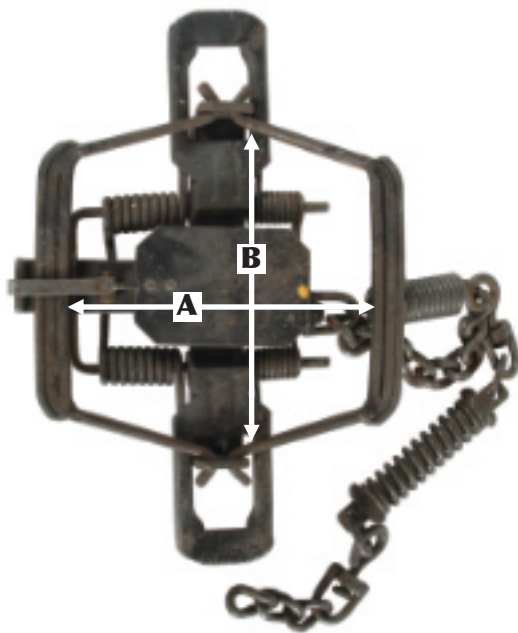

CLOSED TRAP

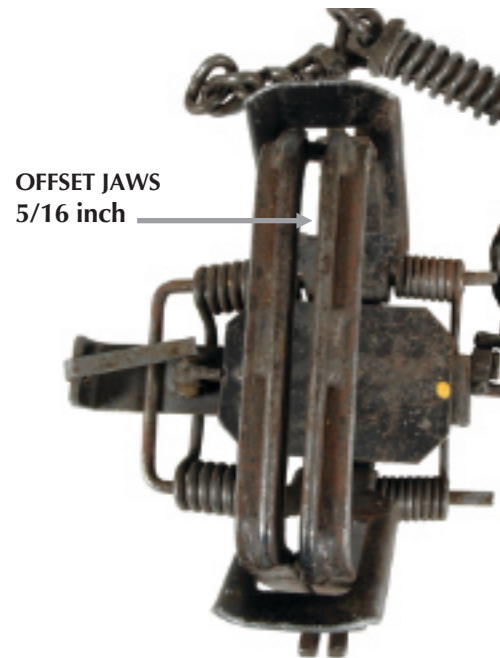

SEE REVERSE FOR MORE COMPONENTS DETAILS

MODEL	AIHTS CERTIFICATION		INSIDE MEASUREMENT TAKEN ON THE SET TRAP	
	NUMBER	TARGET SPECIES	(A)	(B)
N° 3 4 SPRINGS	VYB	Coyote	5 ³ / ₄ inch (146 mm)	5 ⁷ / ₁₆ inch (138 mm)

Commercial name of trap :

**BRIDGER "COIL SPRINGS"
OFFSET + LAMINATED JAWS**

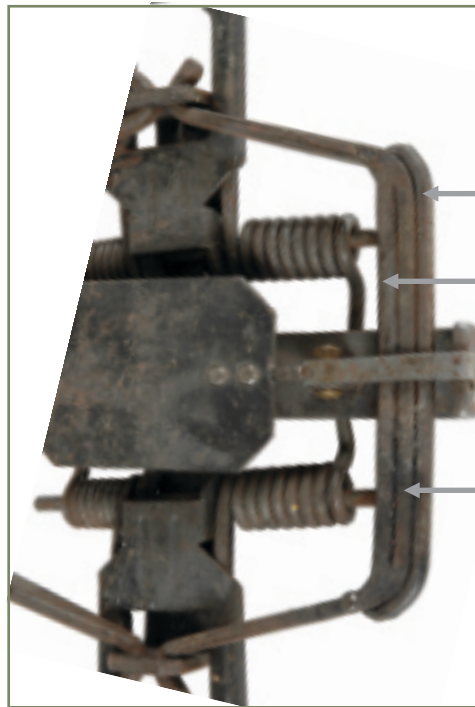

ROUNDED LAMINATIONS

ON TOP END
OF JAW 3/16 inch

ON UNDERSIDE
OF JAW 1/4 inch

JAW



**ANCHORING SWIVEL CENTRE
(MOUNTED ON A BASE PLATE)**



Certified trap identification sheet

BRIDGER "T3"

JANUARY 2024

SET TRAP

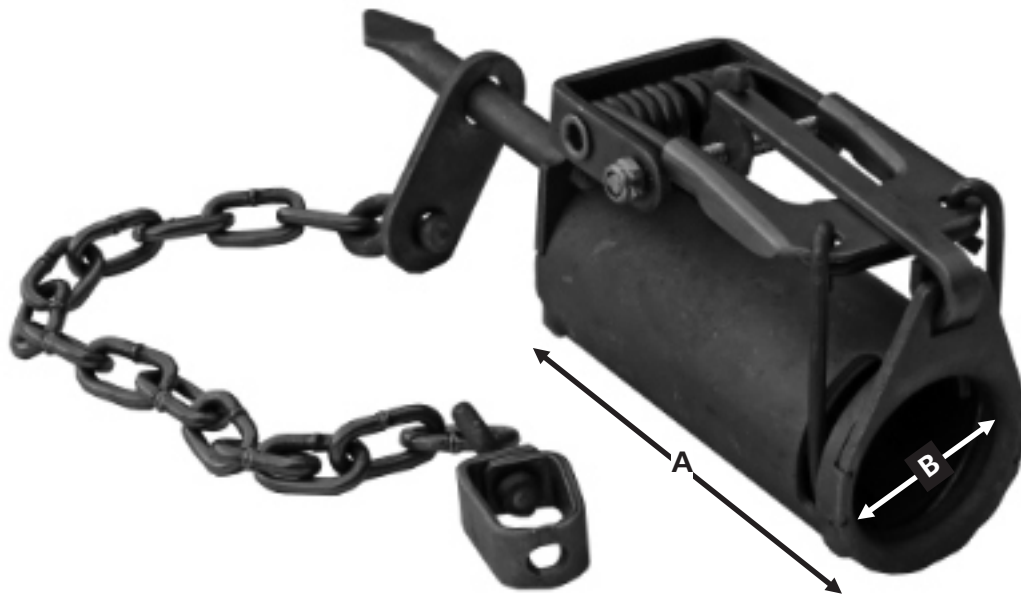

MODEL	AIHTS CERTIFICATION		MEASUREMENTS	
	NUMBER	TARGET SPECIES	(A)	(B)
T3	VRB	Raccoon	4 inch (100 mm)	1 1/4 inch (30 mm)



Certified trap identification sheet

COMSTOCK

JANUARY 2024

SET TRAP



CLOSED TRAP

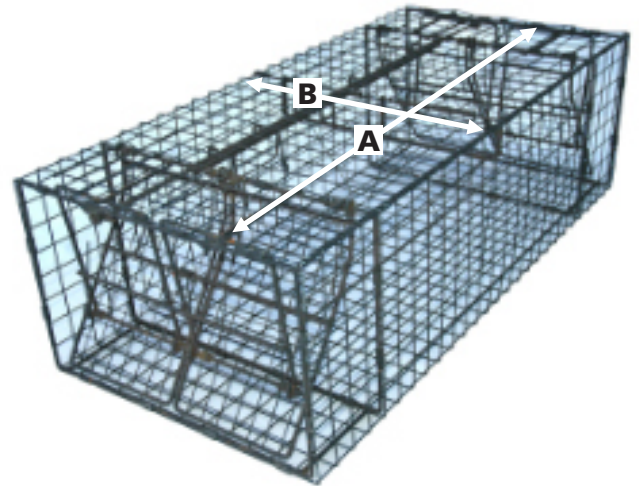

MODEL	AIHTS CERTIFICATION		MEASUREMENTS	
	NUMBER	TARGET SPECIES	(A)	(B)
12X18X39 SWIM THROUGH BEAVER CAGE	VCC	Beaver	39 inch (99 cm)	12 inch (30 cm)



Certified trap identification sheet

DAM BEAVER

JANUARY 2024

SET TRAP



CLOSED TRAP



MODEL	AIHTS CERTIFICATION		MEASUREMENTS	
	NUMBER	TARGET SPECIES	(A)	(B)
DAM BEAVER LIVE BEAVER TRAP	QCP	Beaver	36 ^{1/2} inch (93 cm)	28 inch (71 cm)



Certified trap identification sheet

DUFFER

JANUARY 2024

SET TRAP



AIHTS CERTIFICATION			
MODEL	NUMBER	TARGET SPECIES	WIDTH (A)
RACCOON TRAP	ORH	Raccoon	2 1/2 inch (60 mm)



Certified trap identification sheet

DUKE

JANUARY 2024

CLOSED TRAP

SET TRAP

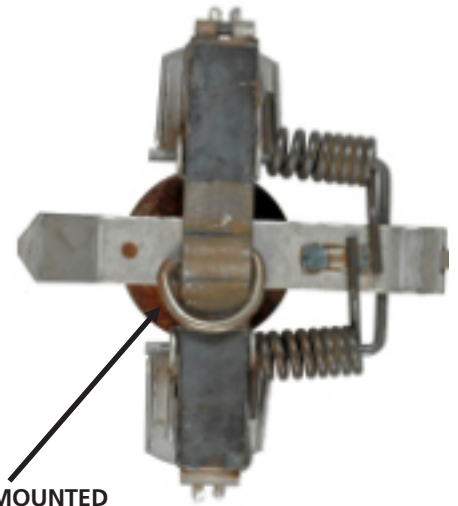
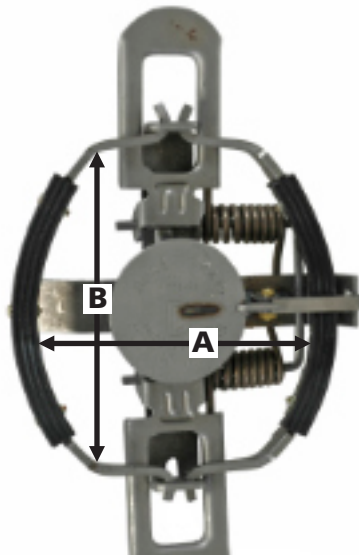

CENTER MOUNTED ANCHORING

MODEL	AIHTS CERTIFICATION		INSIDE MEASUREMENT TAKEN ON THE SET TRAP	
	NUMBER	TARGET SPECIES	(A)	(B)
N° 3 RUBBER JAWS 2 SPRINGS	VYC	Coyote	5 inch (127 mm)	5 ⁷ / ₈ inch (150 mm)



Certified trap identification sheet

DUKE DP

JANUARY 2024

CLOSED TRAP



		AIHTS CERTIFICATION		
MODEL	NUMBER	TARGET SPECIES	WIDTH (A)	
DUKE DP COON TRAP	QRX	Raccoon	1 1/4 inch (30 mm)	



Certified trap identification sheet

EGG TRAP

JANUARY 2024

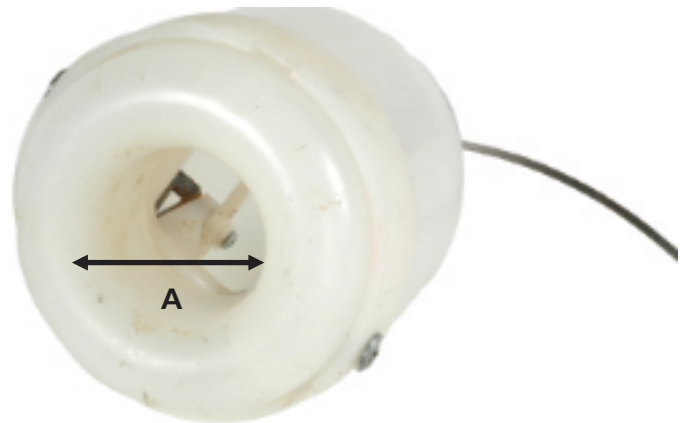

AIHTS CERTIFICATION

MODEL	NUMBER	TARGET SPECIES	(A)
EGG TRAP	VR1	Raccoon	1 1/2 inch (38 mm)



Certified trap identification sheet

EZEE SET

JANUARY 2024

SET TRAP



CLOSED TRAP

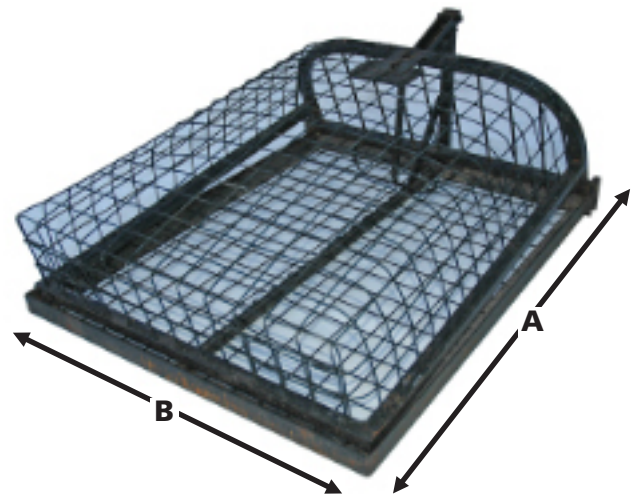

MODEL	AIHTS CERTIFICATION		MEASUREMENTS	
	NUMBER	TARGET SPECIES	(A)	(B)
EZEE SET LIVE BEAVER TRAP	VCA	Beaver	35 inch (89 cm)	28 inch (71 cm)



Certified trap identification sheet

HANCOCK

JANUARY 2024

SET TRAP

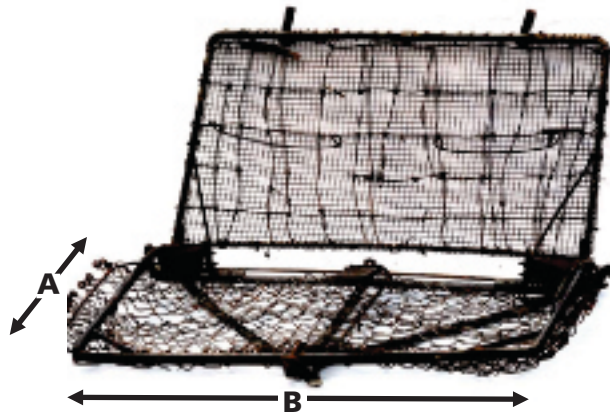

CLOSED TRAP



MODEL	AIHTS CERTIFICATION		MEASUREMENTS	
	NUMBER	TARGET SPECIES	(A)	(B)
HANCOCK LIVE BEAVER TRAP	VCD	Beaver	24 inch (61 cm)	35 inch (89 cm)



Certified trap identification sheet

KORO "KLAM"

JANUARY 2024

SET TRAP

CLOSED TRAP

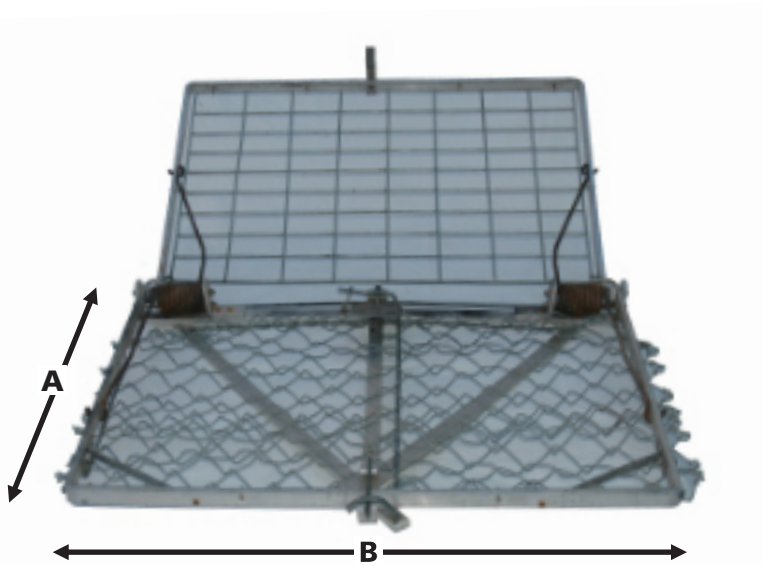

MODEL	AIHTS CERTIFICATION		MEASUREMENTS	
	NUMBER	TARGET SPECIES	(A)	(B)
KORO "KLAM" LIVE BEAVER TRAP	VCB	Beaver	19 1/2 inch (49.4 cm)	32 1/4 inch (82 cm)



Certified trap identification sheet

LAY

JANUARY 2024

CLOSED TRAP

JAW OFFSET WIDTH:
5/16 INCH (8.5 mm)

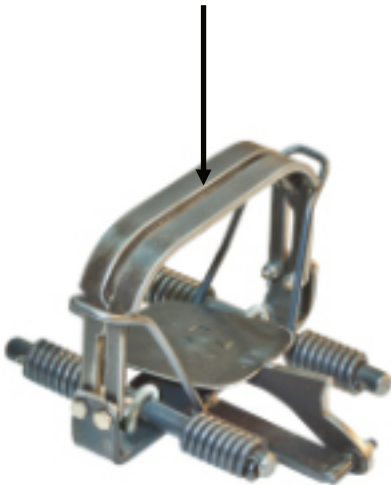

SET TRAP

JAW THICKNESS:
1/2 INCH (13 mm)

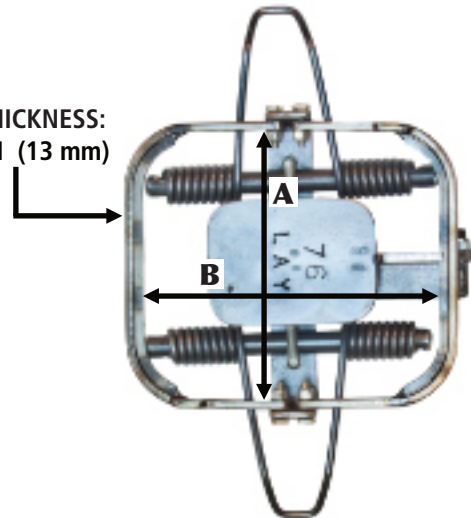

MODEL	AIHTS CERTIFICATION		INSIDE MEASUREMENT TAKEN ON THE SET TRAP	
	NUMBER	TARGET SPECIES	(A)	(B)
N° 76 LAMINATED	CWA	Wolf	7 1/4 inch (185 mm)	8 inch (203 mm)



Certified trap identification sheet

LIL' GRIZZ GETRZ

JANUARY 2024

SET TRAP



AIHTS CERTIFICATION			
MODEL	NUMBER	TARGET SPECIES	WIDTH (A)
LIL' GRIZZ GETRZ	ORI	Raccoon	1 1/4 inch (30 mm)



Certified trap identification sheet

LIVESTOCK PROTECTION

JANUARY 2024

SET TRAP

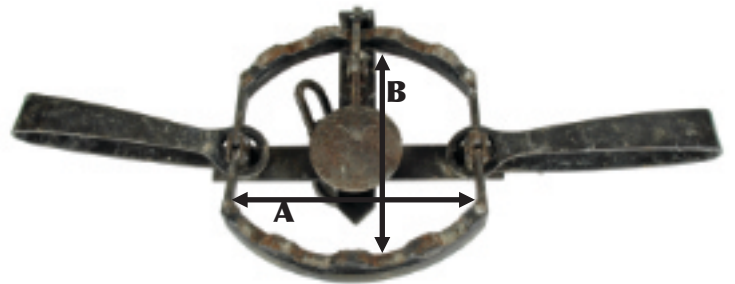

MODEL	AIHTS CERTIFICATION		INSIDE MEASUREMENT TAKEN ON THE SET TRAP	
	NUMBER	TARGET SPECIES	(A)	(B)
EZ GRIP N° 7	QWC	Wolf	6 inch (152 mm)	6 1/4 inch (160 mm)



Certified trap identification sheet

MB

JANUARY 2024

CLOSED TRAP

**750
ALASKAN OS ^{3/8"}**



**550 4CS
RUBBER
JAWS**

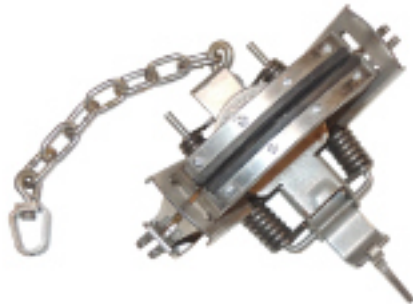

SET TRAP

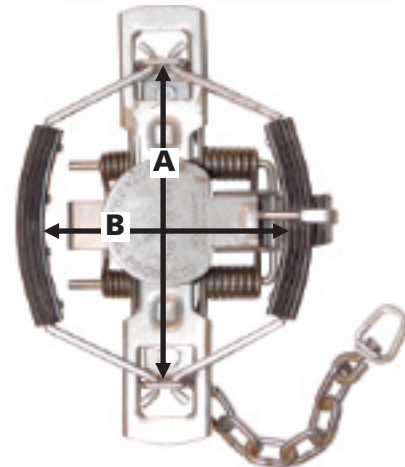
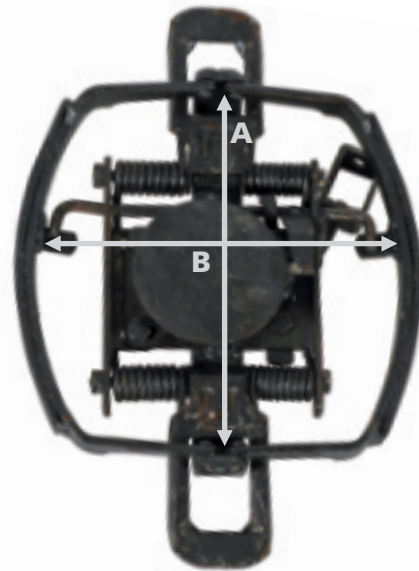

MODEL	AIHTS CERTIFICATION		INSIDE MEASUREMENT TAKEN ON THE SET TRAP	
	NUMBER	TARGET SPECIES	(A)	(B)
ALASKAN OS ^{3/8"}	QWG	Wolf	7 1/4 inch (184 mm)	7 inch (180 mm)
550 4CS RUBBER JAWS	AYA	Coyote	6 1/4 inch (158 mm)	4 3/4 inch (121 mm)



Certified trap identification sheet

MUSKWA

JANUARY 2024

CLOSED TRAP

JAW OFFSET WIDTH:
5/16 INCH (7.5 mm)



SET TRAP

JAW THICKNESS:
1/2 INCH (13 mm)

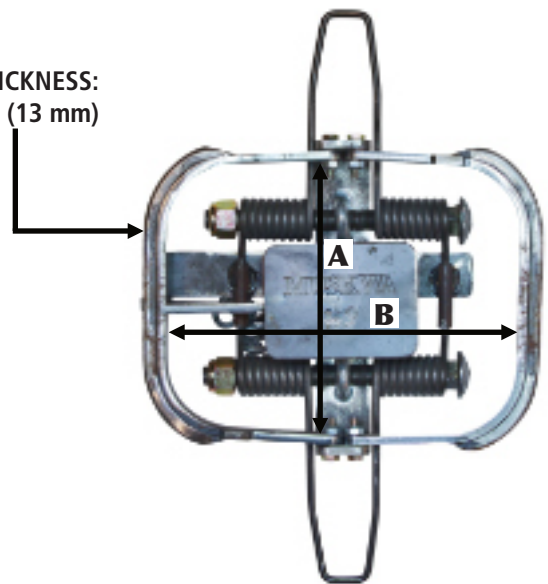

MODEL	AIHTS CERTIFICATION		INSIDE MEASUREMENT TAKEN ON THE SET TRAP	
	NUMBER	TARGET SPECIES	(A)	(B)
N° 9 LAMINATED OFFSET	AWC	Wolf	7 1/4 inch (185 mm)	9 1/4 inch (235 mm)



Certified trap identification sheet

NO-BS-LURES

JANUARY 2024

CLOSED TRAP

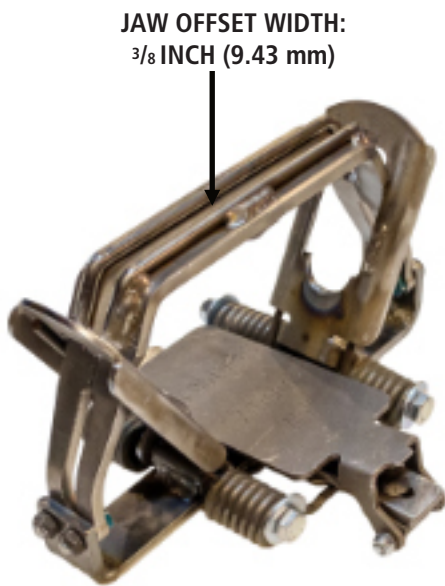

SET TRAP

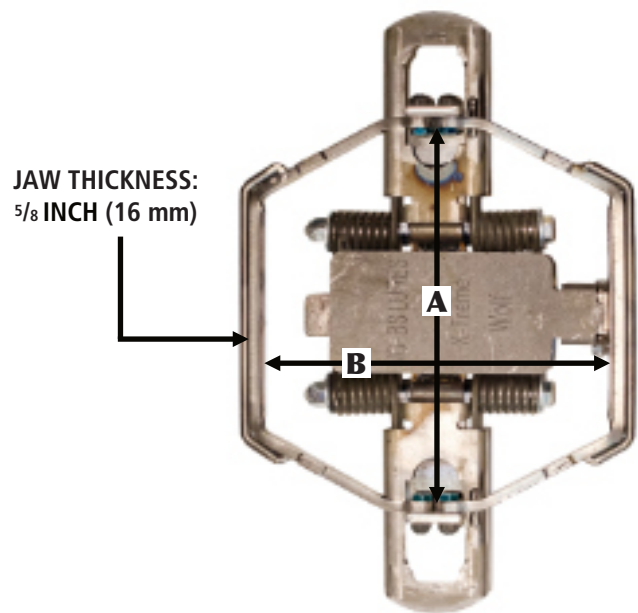

MODEL	AIHTS CERTIFICATION		INSIDE MEASUREMENT TAKEN ON THE SET TRAP	
	NUMBER	TARGET SPECIES	(A)	(B)
X-TREME WOLF	QWP	Wolf	8 ³ / ₄ inch (228 mm)	7 ³ / ₄ inch (197 mm)



Certified trap identification sheet

ONEIDA VICTOR "COIL SPRINGS" OFFSET + LAMINATED JAWS

JANUARY 2024

SET TRAP

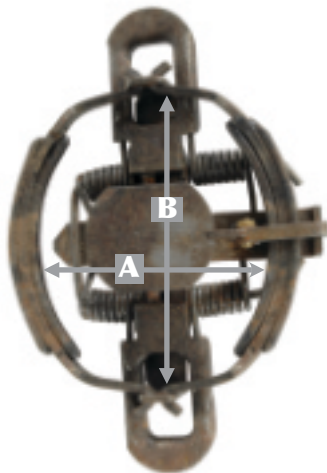

CLOSED TRAPS

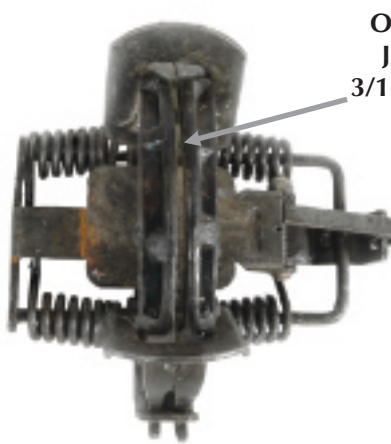

4 SPRINGS



2 SPRINGS

SEE REVERSE FOR MORE COMPONENTS DETAILS

MODEL	AIHTS CERTIFICATION		INSIDE MEASUREMENT TAKEN ON THE SET TRAP	
	NUMBER	TARGET SPECIES	(A)	(B)
N° 1.75 2 SPRINGS	VDB	Bobcat	4 ¹ / ₂ inch (115 mm)	4 ⁵ / ₈ inch (118 mm)
N° 1.75 4 SPRINGS	QYC	Coyote	4 ¹ / ₂ inch (115 mm)	4 ⁵ / ₈ inch (118 mm)
N° 3 2 SPRINGS	QYE	Coyote, Bobcat	4 ³ / ₄ inch (121 mm)	6 inch (153 mm)
N° 3 4 SPRINGS	QYD	Coyote	4 ³ / ₄ inch (121 mm)	6 inch (153 mm)

Commercial name of trap :
**ONEIDA VICTOR "COIL SPRINGS"
OFFSET + LAMINATED JAWS**

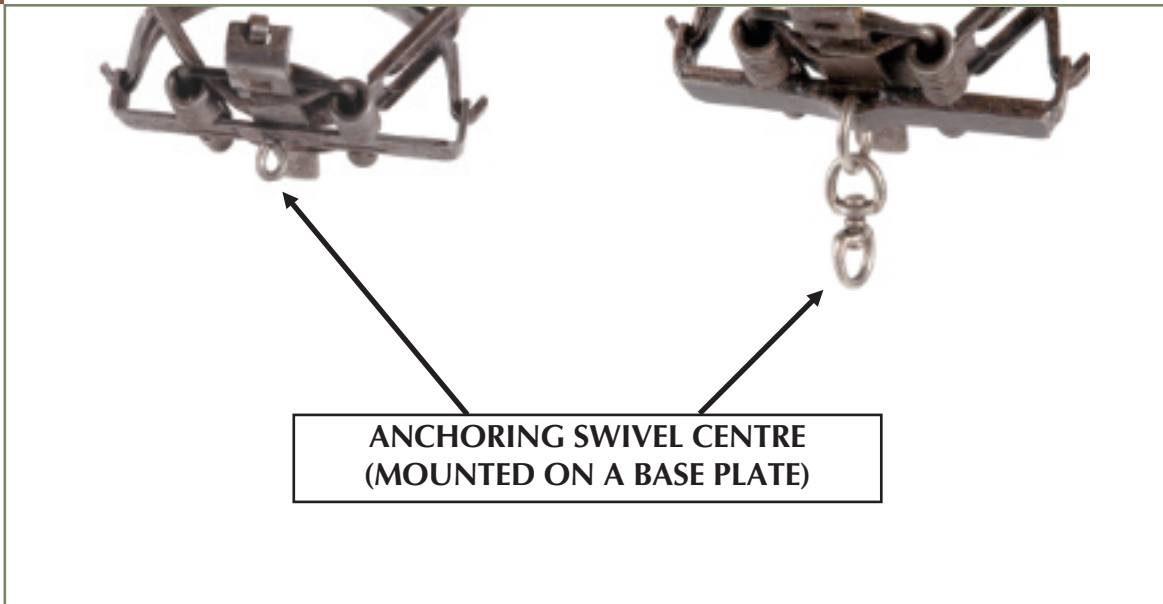
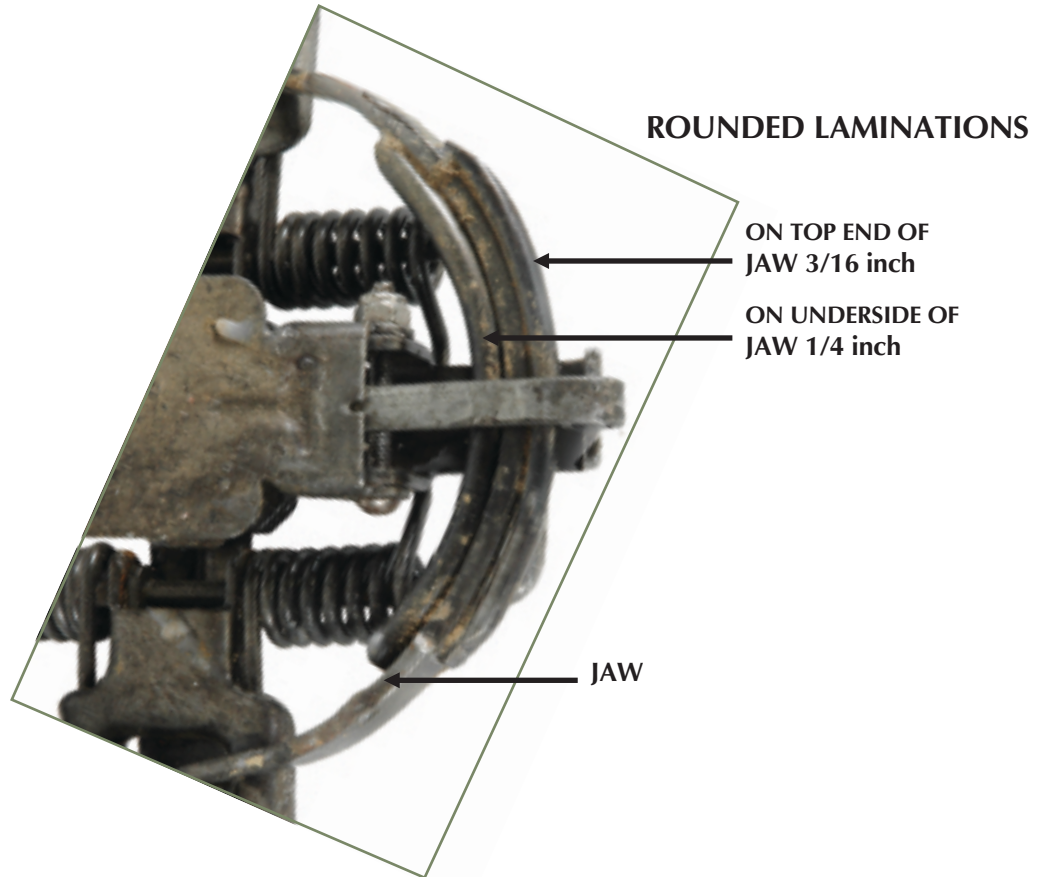



Certified trap identification sheet

ONEIDA VICTOR "COIL SPRINGS" NO 3 NON-OFFSET + LAMINATED JAWS

JANUARY 2024

SET TRAP

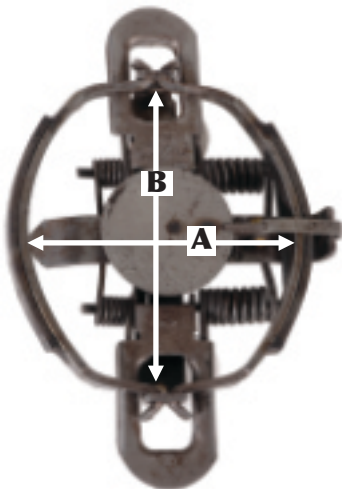

CLOSED TRAP

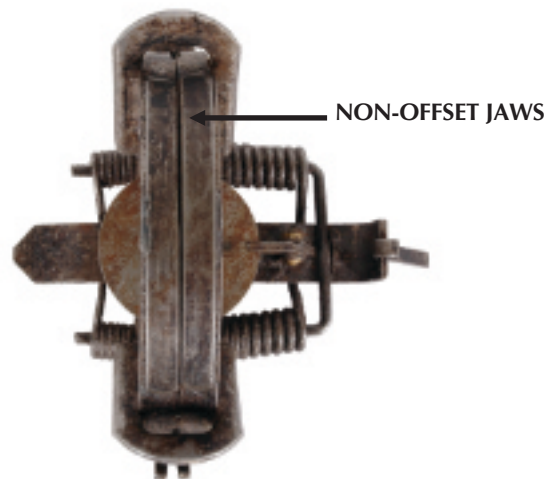

SEE REVERSE FOR MORE COMPONENTS DETAILS

MODEL	AIHTS CERTIFICATION		INSIDE MEASUREMENT TAKEN ON THE SET TRAP	
	NUMBER	TARGET SPECIES	(A)	(B)
N° 3 4 SPRINGS	QLC	Canada Lynx	5 1/4 inch (133 mm)	6 inch (153 mm)

Commercial name of trap :
**ONEIDA VICTOR "COIL SPRINGS"
NO 3
NON-OFFSET + LAMINATED JAWS**

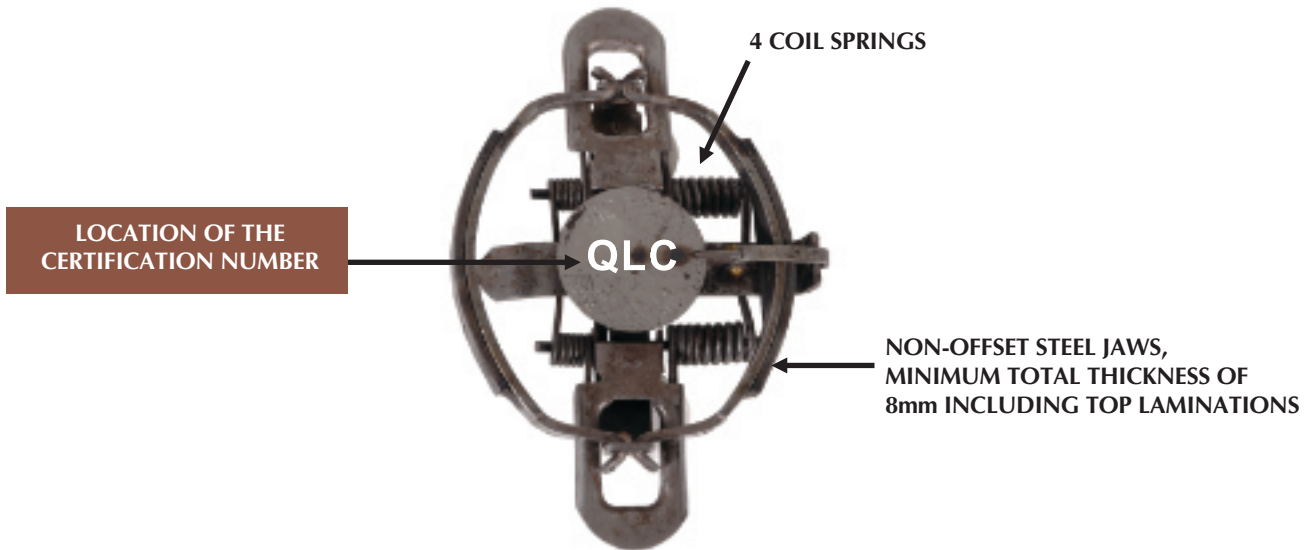

CHARACTERISTICS

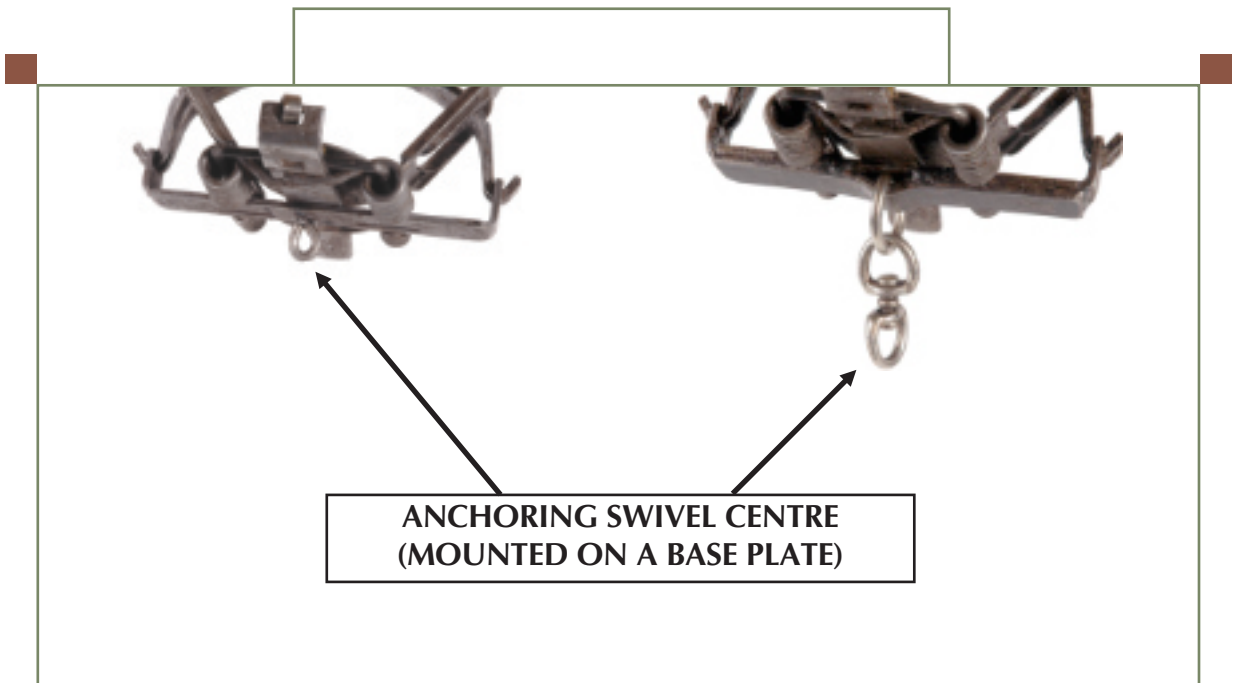



Certified trap identification sheet

ONEIDA VICTOR "SOFT CATCH"

JANUARY 2024

SET TRAP

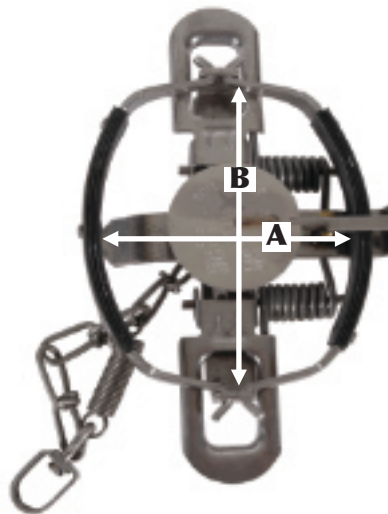

CLOSED TRAP

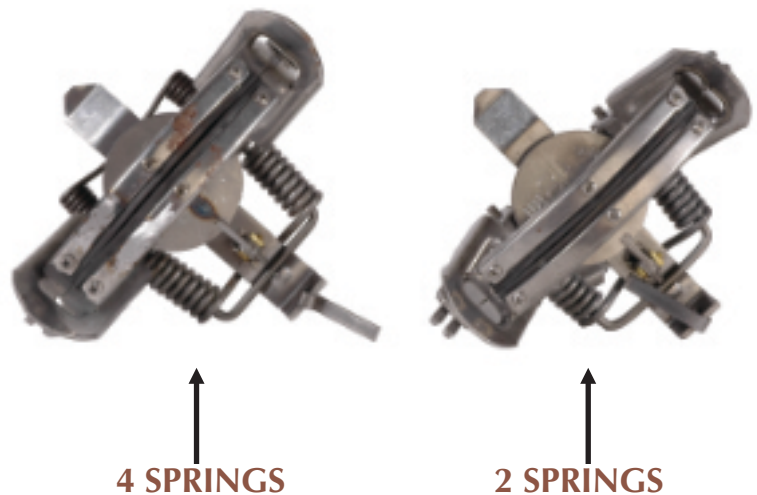

MODEL	AIHTS CERTIFICATION		INSIDE MEASUREMENT TAKEN ON THE SET TRAP	
	NUMBER	TARGET SPECIES	(A)	(B)
N° 1.5 2 SPRINGS	VYA	Coyote	4 ⁵ / ₈ inch (120 mm)	4 ⁵ / ₈ inch (120 mm)
N° 1.5 4 SPRINGS	VDA	Coyote, Bobcat	4 ⁵ / ₈ inch (120 mm)	4 ⁵ / ₈ inch (120 mm)
N° 3 2 SPRINGS	QY1	Canada Lynx, Coyote, Bobcat	5 inch (127 mm)	6 ¹ / ₈ inch (156 mm)
N° 3 4 SPRINGS	QLB	Canada Lynx, Bobcat, Coyote	5 inch (127 mm)	6 ¹ / ₈ inch (156 mm)

Commercial name of trap :
ONEIDA VICTOR
"SOFT CATCH"

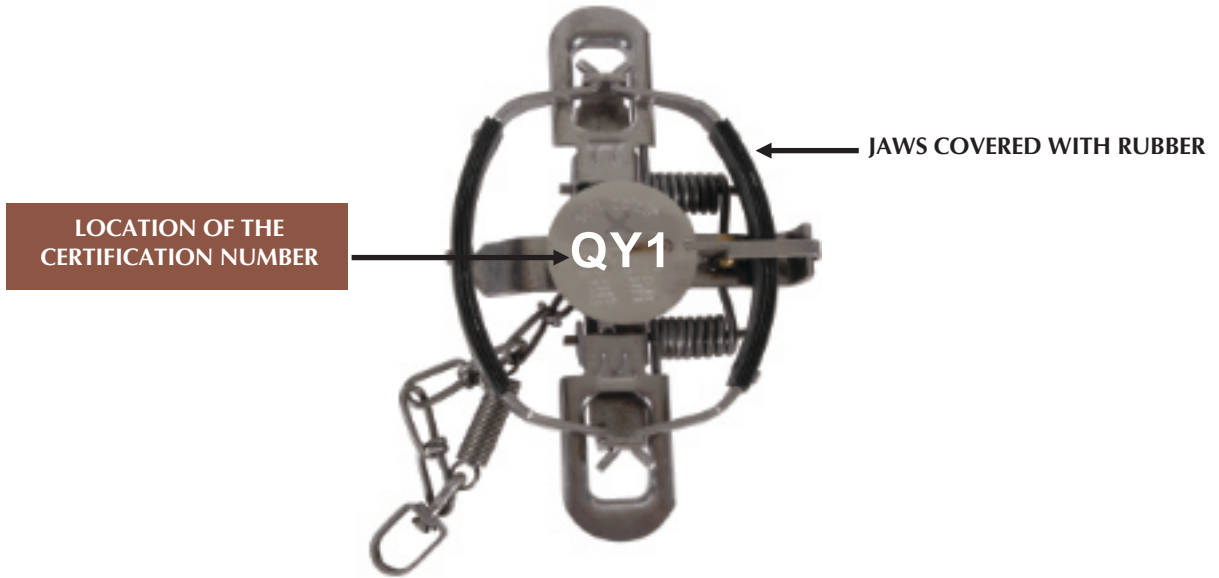

CHARACTERISTICS

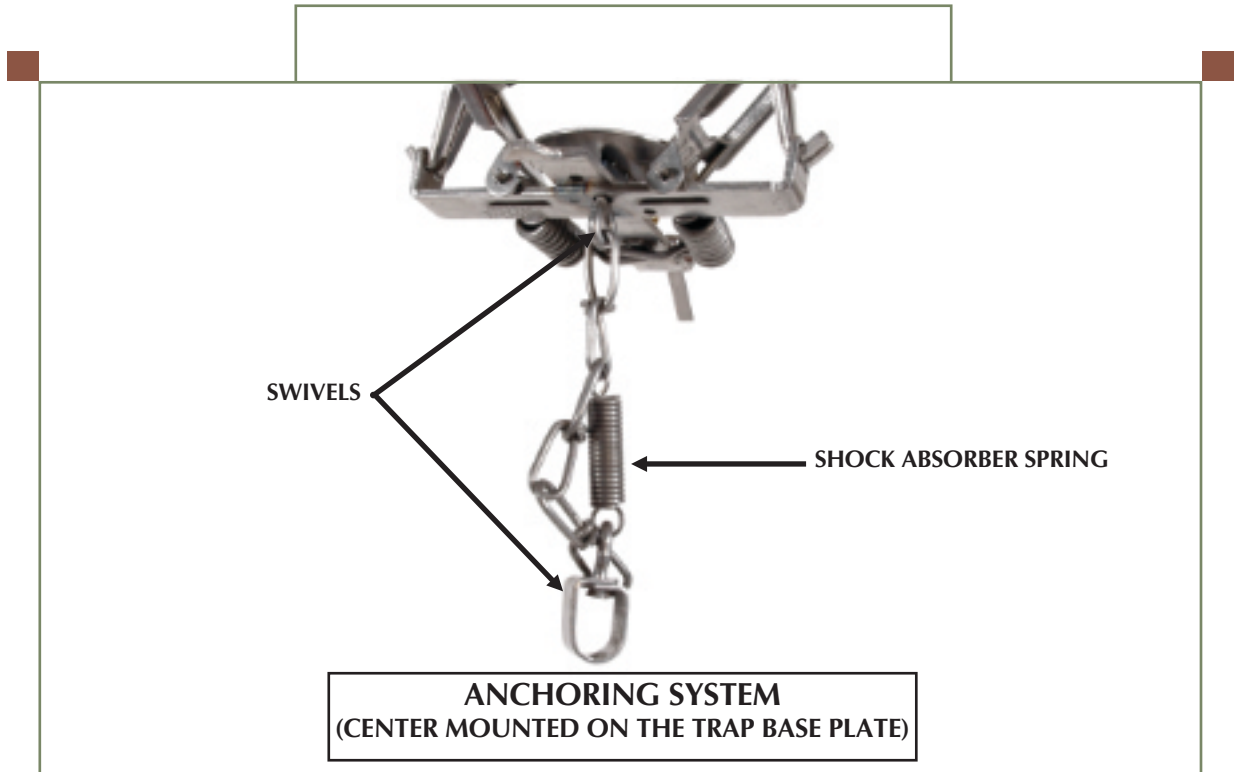



Certified trap identification sheet

ONEIDA VICTOR "SOFT CATCH" NO 3 (MODIFIED FOR WOLF)

JANUARY 2024

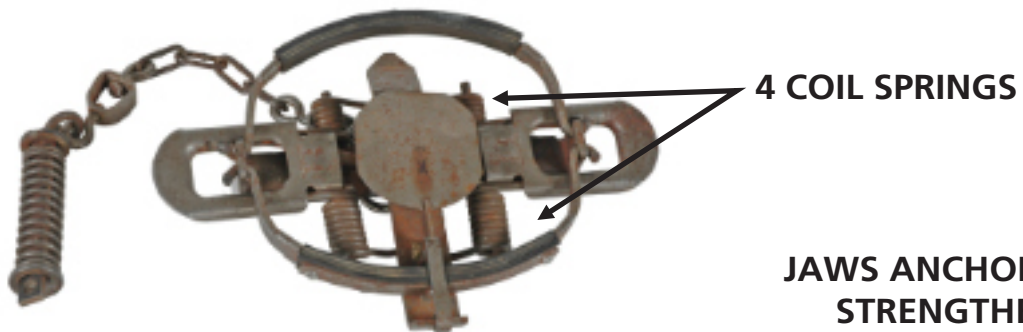

4 COIL SPRINGS

JAWS ANCHORING POINT STRENGTHENED BY WELDING POINTS

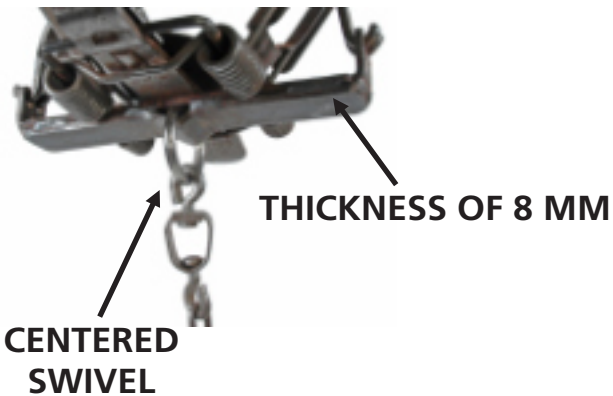

THICKNESS OF 8 MM

CENTERED SWIVEL



AIHTS CERTIFICATION			
MODEL	NUMBER	TARGET SPECIES	CHARACTERISTICS
3 SC (MODIFIED)	QWB	Wolf	<ul style="list-style-type: none"> • 4 coil springs • Minimum 8 mm thick base plate • Centered swivel



Certified trap identification sheet

RUDY RED WOLF

JANUARY 2024

CLOSED TRAP



SET TRAP



MODEL	AIHTS CERTIFICATION		INSIDE MEASUREMENT TAKEN ON THE SET TRAP	
	NUMBER	TARGET SPECIES	(A)	(B)
N° 4 1/2	QWD	Wolf	6 3/8 inch (162 mm)	7 3/8 inch (185 mm)